

DESMER

LEDIMEX

LED MIRRORS

Ledimex Mirrors S.L



DESMER

DESMER S.A.
POLIGONO BEKEA PAB.6-7
48960 GALDAKAO (BIZKAIA)
TLF.944570584-944570590
E.mail: desmer@desmer.es Web: www.desmer.es

LEDIMEX

LED MIRRORS



Ledimex Mirrors S,L.

Somos una empresa ubicada en Picassent (Valencia), dedicada a la fabricación y comercialización de espejos de led.

Todos nuestros productos son de alta calidad, utilizando las últimas tecnologías tanto en las lunas de los espejos como en los leds o drivers.

El diseño, la agilidad en el servicio, la cuidada atención a nuestros clientes y una excelente relación calidad precio, son una prioridad.



Ledimex Mirrors S,L.

We are a company located in Picassent (Valencia), dedicated to the manufacture and commercialisation of led mirrors.

All our products are high quality, using the latest technologies both in the mirror lens and in the leds or drivers.

The design, the agility in the service, the careful attention to our customers and an excellent value for money, are our priorities.



Ledimex Mirrors S,L.

Nous sommes une entreprise située à Picassent (Valencia) spécialisée dans la fabrication et la commercialisation des miroirs led.

Tous nos produits sont de haute qualité, utilisant les dernières technologies tant dans les verres miroirs comme dans les leds et les drivers. Nos produits sont conformes à la réglementation et agréments techniques standards européens.

Le design, l'agilité du service, l'attention particulière à nos clients et un excellent rapport qualité-prix, sont notre priorité.



Ledimex Mirrors S,L.

Somos uma empresa localizada em Picassent em Valência, dedicada á fabricação e comercialização de espelhos de led.

Todos os nossos productos são de alta qualidade, usando as ultimas tecnologías, tanto nas luas de espelhos como em leds ou drivers.

O desenho (design), a agilidade no serviço, o cuidado com os nossos clientes e uma excelente relação de qualidade/preço, são uma prioridade.



ESPEJO RESISTENTE A LA CORROSIÓN

- Nuestros espejos han superado pruebas especiales de salinidad marina que demuestra que es un espejo altamente resistente a los agentes externos.
- Todos nuestros espejos tienen un grosor de cristal de 5mm que le aporta una mayor resistencia a los golpes además de contar con vidrios anti-explisión.
- Espejos con plateado sin presencia de cobre.
- Fuente de alimentación IP44 resistente al agua.
- Todos los premarcos traseros de los espejos son de aluminio para que absorban el calor de los leds y proteger la durabilidad del mismo.
- El número de diodos por metro son de 120 por metro lineal.
- Todos nuestros leds son de alta reproducción cromática IRC 80» y van protegidos con una cobertura de silicona que a su vez difieren la luz de manera homogénea y evitando que se vean los puntos de led.



MIROIR RÉSISTANT À LA CORROSION

- Nos miroirs ont passé des tests spéciaux de salinité en mer, ce qui prouve qu'il s'agit d'un miroir très résistant aux agents extérieurs.
- Tous nos miroirs ont une épaisseur de verre de 5 mm, ce qui les rend plus résistants aux chocs avec vitre de sécurité anti-éclatement.
- Argenté sans présence de cuivre
- Source de courant IP44 résistante à l'eau.
- Tous les cadres arrière des miroirs sont en aluminium afin d'absorber la chaleur des diodes et de protéger la durabilité du miroir.
- Le nombre de diodes par mètre est de 120 par mètre linéaire.
- Tous nos leds ont un indice de reproduction chromatique IRC 80 » et sont protégées par un revêtement en silicone qui diffuse la lumière de manière uniforme et empêche les spots LED d'être visibles.



ENVIRONMENTAL PROTECTION



5MM THICKNESS



CNC water jet chamfering

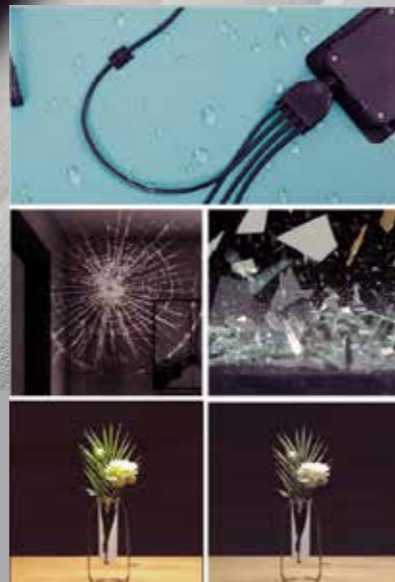

CORROSION RESISTANT MIRROR

- Our mirrors have passed special tests of marine salinity which proves that it is a mirror highly resistant to external agents.
- All our mirrors have a glass thickness of 5mm which makes them more resistant to shocks and anti-burst safety glass
- Silver with copper-free
- IP44 waterproof power supply
- All the back frames of the mirrors are made of aluminum to absorb the heat of the LEDs and protect the durability of the mirror.
- The number of diodes per meter is 120 per linear meter.
- All our LEDs are with high color rendering CRI»80 and there are protected with a silicone cover that differs the light in a homogeneous way and avoiding the LED points to be seen.



ESPELHO RESISTENTE À CORROSSÃO

- Os nossos espelhos superaram provas especiais de sal marinha que demonstra que é um espelho altamente resistente aos agentes externos.
- Todos os nossos espelhos tem um grossor de cristal de 5mm que lhe aporta uma maior resistência a todos os golpes, além de contar com os vidrios anti explosão.
- Todos os espelhos contam com um prateado sem presença de cobre.
- Fonte de alimentação IP44 resistente á água.
- Os nossos espelhos têm uma pre estrutura de alumínio conseguindo assim absorver o calor emitido pelo diodo led e proporcionando uma maior durabilidade a estos.
- O numero de diodos por metro são de: 120 por metro linhal.
- Todos os nossos leds, são de alta reprodução cromática IRC 80» com revestimento de silicone, protegendo a tira de led evitando que se vejam diodos emissores de luz, conseguido uma luz homogénea em sua totalidade.

STRUCTURE AND COMPOSITION

OF ENVIRONMENTALLY FRIENDLY MIRRORS

Real MATERIALS

Environmentally friendly material selection From inside out Creating high-quality products Durable and long-lasting

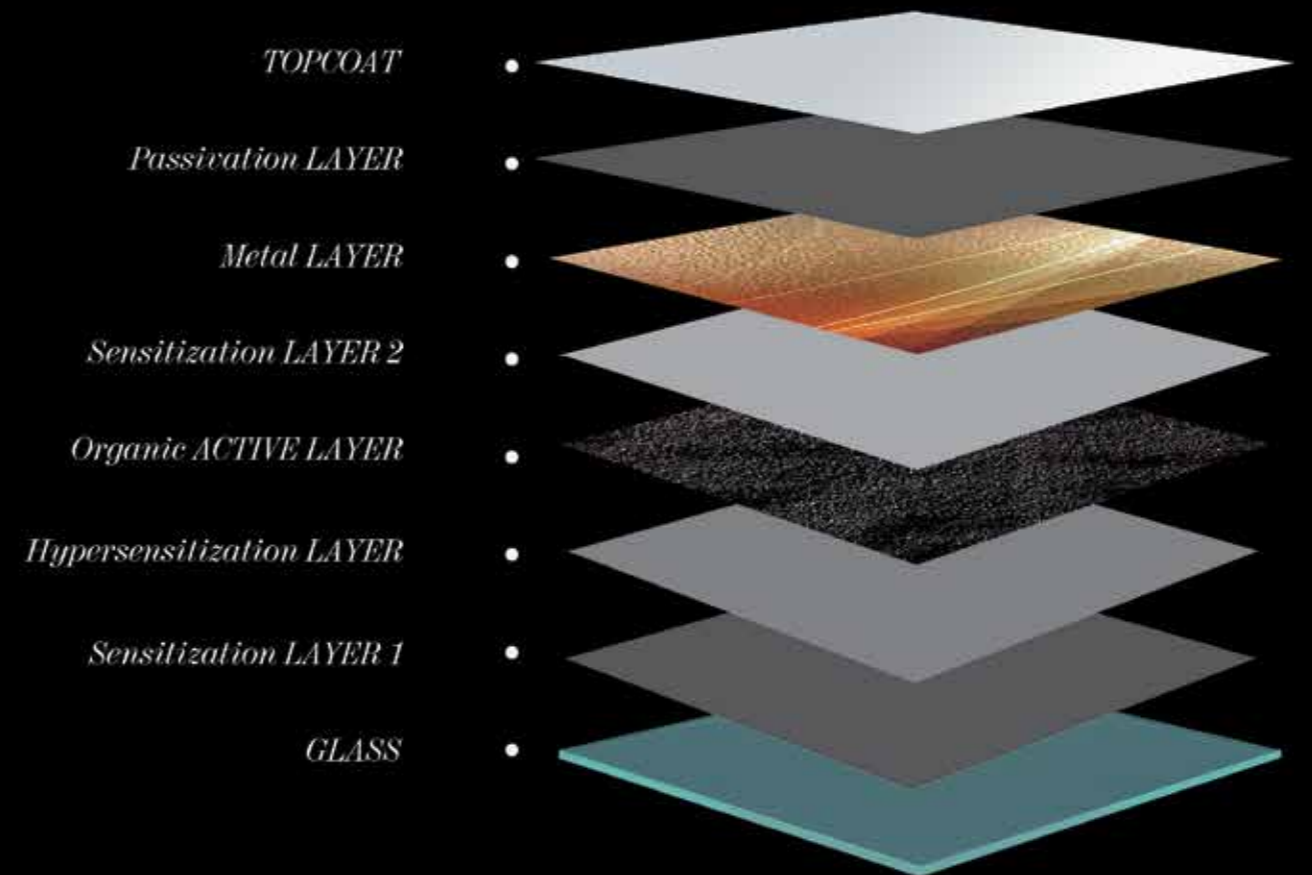

PACKAGE



- Packing con doble protección para garantizar un transporte seguro.
- Packing exterior fabricado en cartón de alto gramaje.
- Packing interior de foam para proteger el espejo de golpes.



- Packing with double protection to guarantee a safe transport.
- Outer packaging made of heavyweight cardboard.
- Inner packing made of foam to protect the mirror from knocks and bumps.



- Emballage avec double protection pour garantir un transport sûr.
- Emballage extérieur en carton de haut grammage.
- Emballage intérieur en mousse pour protéger le miroir des coups et des chocs.



- Embalagem com dupla proteção para garantir um transporte seguro.
- Embalagem exterior em cartão de alta gramagem.
- Embalagem interior em espuma para proteger o espelho de choques e pancadas.

LEDIMEX • *índice / index*

LUZ PERIMETRAL ENCAPSULADA EN EL MARCO / PERIMETER LIGHT INTEGRATED IN THE FRAME /
LUMIÈRE PÉRIMÉTRIQUE INTÉGRÉE DANS LE CADRE / ESPELHO COM LUZ PERIMETRAL INTEGRADA NO MARCO



NEPAL SERIES 008-011 ABILITY SERIES 012-015 RIO SERIES 016-019 ROMA SERIES 020-023

MARCO ILUMINADO / ILLUMINATED FRAME / CADRE ENTièrement ÉCLAIRE / MARCO ILUMINADO



INDIANA SERIES 024-027 ATENAS SERIES 028-031 BOSTON SERIES 032-035 CANADA SERIES 036-039

LUZ FRONTAL / FRONT LIGHT / ÉCLAIRAGE FRONTAL / LUZ FRONTAL



PARIS SERIES 040-043 SUIZA SERIES 044-047 NEW YORK SERIES 048-051 MALTA SERIES 052-053

LUZ RETROILUMINADA CON SALIDA FRONTAL / BACKLIGHT & FRONTLIGHT /
LUMIÈRE RÉTRO-ÉCLAIRÉE AVEC SORTIE FRONTALE / LUZ RETROILUMINADA CON SALIDA FRONTAL

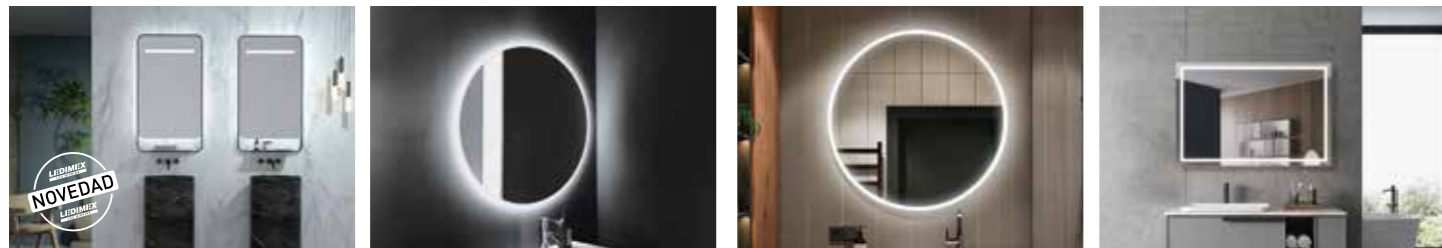

CONCEPT SERIES 054-057 BELGICA SERIES 058-059 LONDRES SERIES 060-061 FRANCIA SERIES 062-063

LUZ RETROILUMINADA CON SALIDA FRONTAL / BACKLIGHT & FRONTLIGHT /
LUMIÈRE RÉTRO-ÉCLAIRÉE AVEC SORTIE FRONTALE / LUZ RETROILUMINADA CON SALIDA FRONTAL



HOLANDA SERIES 064-065 AUSTRIA SERIES 066-067 GRECIA SERIES 068-069 PRAGA SERIES 070-071

LUZ RETROILUMINADA / BACKLIGHT / LUMIÈRE RÉTRO-ÉCLAIRÉE / LUZ RETROILUMINADA



TOKYO SERIES 072-075 CARDIFF&GALES SERIES 076-079 FUN SERIES 080-083 CALIFORNIA SERIES 084-087

LUZ RETROILUMINADA / BACKLIGHT / LUMIÈRE RÉTRO-ÉCLAIRÉE / LUZ RETROILUMINADA



OPORTO SERIES 090-091 LISBOA SERIES 092-093 SUECIA SERIES 094-097 ITALIA SERIES 098-101

LUZ RETROILUMINADA / BACKLIGHT / LUMIÈRE RÉTRO-ÉCLAIRÉE / LUZ RETROILUMINADA



DINAMARCA SERIES 102-103 OVAL SERIES 104-105

NEPAL SERIES





- Espejo con luz perimetral integrada en el marco que aporta un ambiente decorativo.
- Diseñado específicamente para devolver un reflejo de alta calidad y una gran iluminación de manera indirecta que no sea molesta para la vista.
- Espejo redondo de luz perimetral integrada en marco de aluminio en acabado negro mate.
- Doble sensor. On/off y antivaho.
- Tres tipos de luz (cálida 3.000K, neutra 4.000K y fría 6.500K)



- Mirror with perimeter light integrated in the frame that provides a decorative atmosphere.
- Specifically designed to return a high quality reflection and a great lighting in an indirect way that is not disturbing to the eye.
- Round mirror with integrated perimeter light in aluminum frame in matte black finish.
- Double sensor. On/off and anti-fog.
- Three types of light (warm 3,000K, neutral 4,000K and cold 6,500K).



- Miroir avec lumière périmétrique intégrée dans le cadre qui procure une ambiance décorative.
- Spécialement conçu pour renvoyer un reflet de haute qualité et un grand éclairage de manière indirecte et non gênante pour l'œil.
- Miroir rond avec éclairage périmétrique intégré dans un cadre en aluminium finition noir mat.
- Double capteur. On/Off et anti-buée
- Trois types de lumière (chaude 3000 K, neutre 4000 K et froide 6500 K).



- Espelho com luz perimetral integrada no marco aportando um ambiente decorativo.
- Desenhado especificamente para devolver um reflexo de alta qualidade e uma grande iluminação mas sem irritar a vista.
- Espelho redondo de luz perimetral integrada no marco de alumínio disponível em Preto mate.
- Duplo sensor ON/OFF e anti-embaciamento
- 3 tipos de luz (quente 3.000K, neutra 4.000 e fria 6.500K)

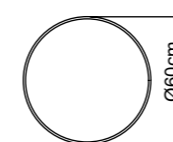

NEPA031/60NG
Ø60 cm
Precio: 179€

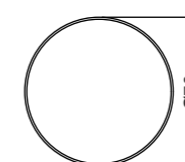

NEPA031/70NG
Ø70 cm
Precio: 199€

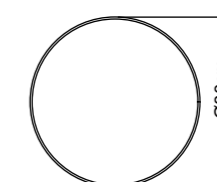

NEPA031/80NG
Ø80 cm
Precio: 229€

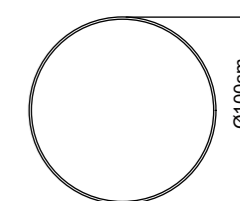

NEPA031/100NG
Ø100 cm
Precio: 259€



ABILITY
SERIES





- Espejo con luz perimetral integrada en el marco que aporta un ambiente decorativo.
- Diseñado específicamente para devolver un reflejo de alta calidad y una gran iluminación de manera indirecta que no sea molesta para la vista.
- Espejo cuadrado de luz perimetral integrada en marco de aluminio disponible en 2 acabados. Negro mate y PVD Oro cepillado.
- Sistema de encendido mediante sensor oculto en el marco.
- Antivaho incorporado.
- Tres tipos de luz (cálida 3.000K, neutra 4.000K y fría 6.500K)



- Miroir avec lumière périmétrique intégrée dans le cadre qui procure une ambiance décorative.
- Spécialement conçu pour renvoyer un reflet de haute qualité et un grand éclairage d'une manière indirecte qui ne dérange pas l'œil.
- Miroir rectangulaire avec lumière périphérique intégrée dans un cadre en aluminium disponible en 2 finitions. Noir mat et PVD or brossé.
- Système de commutation par capteur caché dans le cadre.
- Anti-buée intégré.
- Trois types de lumière (chaude 3000K, neutre 4000K et froide 6500K).



- Mirror with perimeter light integrated in the frame that provides a decorative atmosphere.
- Specifically designed to return a high quality reflection and a great lighting in an indirect way that is not disturbing to the eye.
- Square mirror with integrated perimeter light in aluminum frame available in 2 finishes. Matte black and PVD brushed gold.
- Switching system by sensor hidden in the frame.
- Built-in anti-fogging.
- Three types of light (warm 3.000K, neutral 4.000K and cold 6.500K).



- Espelho com luz perimetral integrada no marco aportando um ambiente decorativo.
- Desenhado especificamente para devolver um reflexo de alta qualidade e uma grande iluminação mas sem irritar a vista.
- Espelho quadrado de luz perimetral integrada no marco de alumínio disponível em 2 acabamentos. Preto mate e ouro mate PVD.
- Sistema de ligação mediante sensor oculto no marco.
- Anti-embaciamento integrado.
- 3 tipos de luz (quente 3.000K, neutra 4.000 e fria 6.500K)

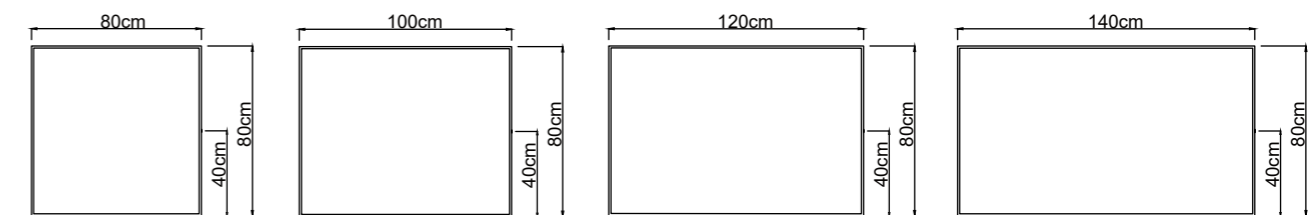

ACABADO FINISH

ABIL033/80NG
80 x 80 cm
Precio: **198€**

ABIL033/100NG
100 x 80 cm
Precio: **224€**

ABIL033/120NG
120 x 80 cm
Precio: **256€**

ABIL033/140NG
140 x 80 cm
Precio: **277€**

ACABADO FINISH

ABIL033/80OC
80 x 80 cm
Precio: **198€**

ABIL033/100OC
100 x 80 cm
Precio: **224€**

ABIL033/120OC
120 x 80 cm
Precio: **256€**

ABIL033/140OC
140 x 80 cm
Precio: **277€**

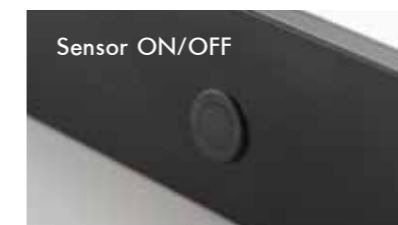

• MATTE BLACK



• BRUSHED GOLD

RIO
SERIES





- Espejo con luz perimetral integrada en el marco que aporta un ambiente decorativo.
- Diseñado específicamente para devolver un reflejo de alta calidad y una gran iluminación de manera indirecta que no sea molesta para la vista.
- Espejo elíptico de luz perimetral integrada en marco de aluminio en acabado negro mate.
- Doble sensor. On/off y antivaho.
- Tres tipos de luz (cálida 3.000K, neutra 4.000K y fría 6.500K)



- Miroir avec lumière périmétrique intégrée dans le cadre qui fournit une ambiance décorative.
- Spécialement conçu pour renvoyer un reflet de haute qualité et un grand éclairage de manière indirecte et non gênante pour l'œil.
- Miroir avec lumière périmétrique intégrée dans un cadre en aluminium avec finition noire mate.
- Double capteur. On/Off et anti-buée
- Trois types de lumière (chaude 3000 K, neutre 4000 K et froide 6500 K).



- Mirror with perimeter light integrated in the frame that provides a decorative atmosphere.
- Specifically designed to return a high quality reflection and a great lighting in an indirect way that is not disturbing to the eye.
- Mirror with integrated perimeter light in aluminum frame in matte black finish.
- Double sensor. On/off and anti-fog.
- Three types of light (warm 3.000K, neutral 4.000K and cold 6.500K).



- Espelho com luz perimetral integrada no marco aportando um ambiente decorativo.
- Desenhado especificamente para devolver um reflexo de alta qualidade e uma grande iluminação mas sem irritar a vista.
- Espelho com marco em preto mate.
- Duplo sensor ON/OFF e anti-embaciamento.
- 3 tipos de luz (quente 3.000K, neutra 4.000 e fria 6.500K)

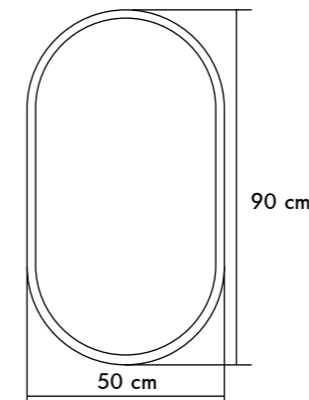

RIO035/90NG

50 x 90 cm €

Precio: **232€**



ROMA
SERIES





- Espejo con luz perimetral integrada en el marco que aporta un ambiente decorativo.
- Diseñado específicamente para devolver un reflejo de alta calidad y una gran iluminación de manera indirecta que no sea molesta para la vista.
- Espejo tipo capilla de luz perimetral integrada en el marco.
- Doble sensor. On/off y antivaho
- Tres tipos de luz (cálida 3.000K, neutra 4.000K y fría 6.500K)



- Miroir avec lumière périmétrique intégrée dans le cadre qui fournit une ambiance décorative.
- Spécialement conçu pour renvoyer un reflet de haute qualité et un grand éclairage de manière indirecte et non gênante pour l'œil.
- Miroir chapelle avec lumière périmétrique intégrée dans le cadre.
- Double capteur. On/Off et anti-buée.
- Trois types de lumière (chaude 3000K, neutre 4000K et froide 6500K)



- Mirror with perimeter light integrated in the frame that provides a decorative atmosphere.
- Specifically designed to return a high quality reflection and a great lighting in an indirect way that is not disturbing to the eye.
- Chapel mirror with perimeter light integrated in the frame.
- Double sensor. On/off and anti-fog.
- Three types of light (warm 3,000K, neutral 4,000K and cold 6,500K).



- Espelho com luz perimetral integrada no marco que aporta um ambiente decorativo
- Desenhado especificamente para devolver um reflexo de alta qualidade e uma grande iluminação mas sem irritar a vista.
- Espelho tipo 'capela' de luz perimetral integrada no marco.
- Duplo sensor ON/OFF e anti-embaciamento.
- 3 tipos de luz (quente 3.000K, neutra 4.000 e fria 6.500K)

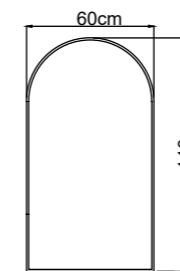

ROMA025/110NG

60 x 110 cm

Precio: **224€**

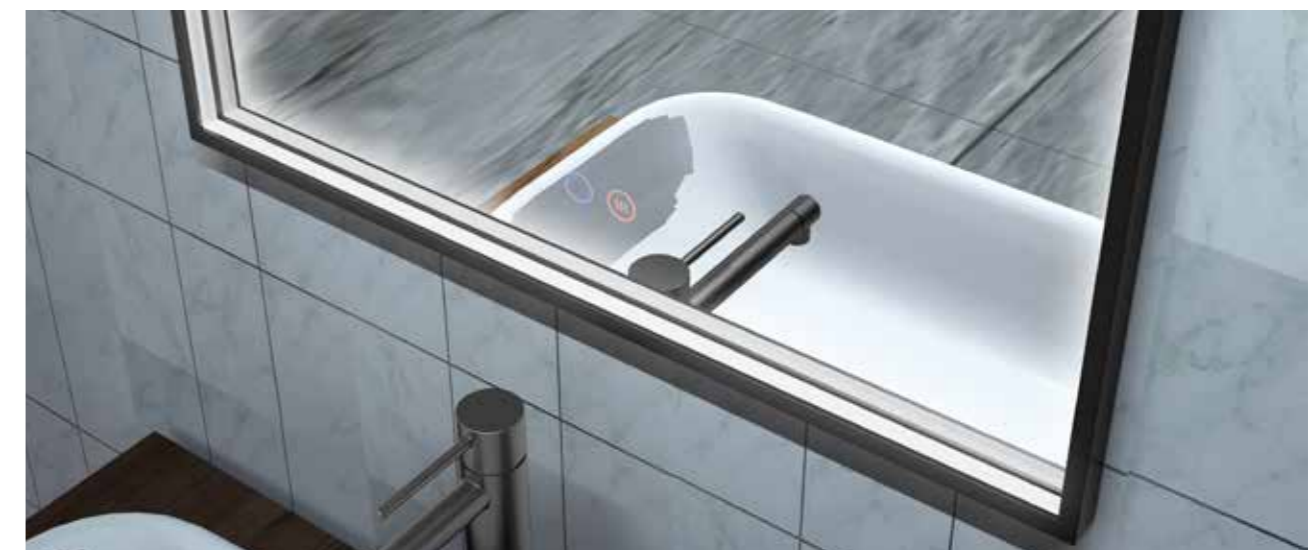
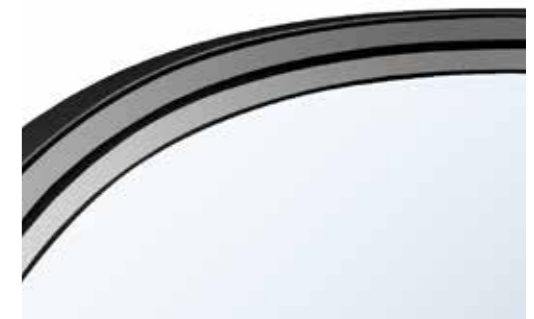

INDIANA
SERIES

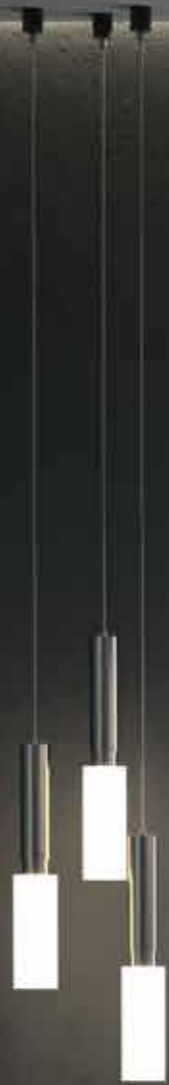



- Espejo con encendido y apagado secuencial que combina el diseño con la funcionalidad al incorporar un espejo de aumento.
- Espejo elíptico con marco iluminado acrílico.
- Espejo de aumento x3
- Sistema de encendido secuencial
- Intensidad de luz regulable
- Antivaho incorporado
- Luz fría 6.500K



- Mirror with sequential on/off that combines design with functionality by incorporating a magnifying mirror.
- Elliptical mirror with illuminated acrylic frame
- Magnifying mirror x3
- Sequential on/off system
- Adjustable light intensity
- Built-in anti-fogging
- Cold light 6,500K



- Miroir avec interrupteur séquentiel on/off qui combine design et fonctionnalité en incorporant un miroir grossissant.
- Miroir elliptique avec cadre acrylique
- Miroir grossissant x3
- Système d'allumage séquentiel
- Intensité lumineuse réglable
- Anti-buée intégré
- Lumière froide 6500K



- Espelho com ligação e desligamento sequencial que combina design com funcionalidade ao incorporar um espelho de aumento.
- Espelho elíptico com marco iluminado acrílico
- Espelho de aumento 3X
- Sistema de ignição sequencial
- Intensidade de luz ajustável
- Anti-embaciamento integrado
- Luz fria de 6.500K

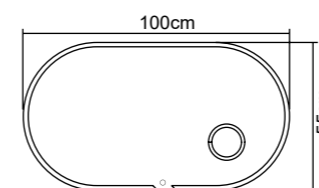

INDI027/100
100 x 55 cm
Precio: **338€**

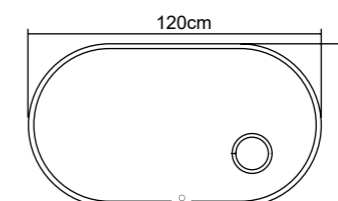

INDI027/120
120 x 60 cm
Precio: **364€**

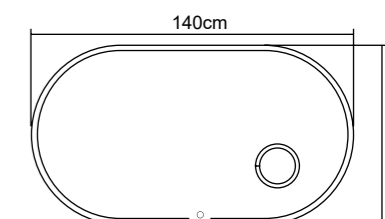

INDI027/140
140 x 70 cm
Precio: **444€**

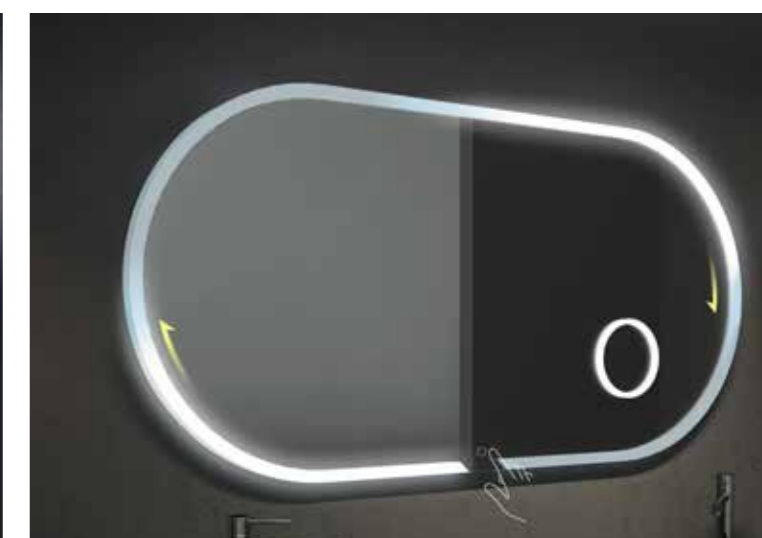

ATENAS

SERIES





- Espejo con marco totalmente iluminado que aporta una mayor cantidad de luz y que está especialmente concebido para cuartos de baño con poca luminosidad
- Espejo redondo con marco iluminado de PVC
- Doble sensor. On/off y antivaho
- Tres tipos de luz (cálida 3.000K, neutra 4.000K y fría 6.500K)

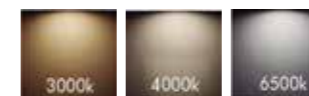

- Mirror with fully illuminated frame that provides a greater amount of light and is specially designed for bathrooms with low luminosity.
- Round mirror with illuminated PVC frame.
- Double sensor. On/off and anti-fog
- Three types of light (warm 3,000K, neutral 4,000K and cold 6,500K).



- Miroir avec un cadre entièrement éclairé qui fournit plus de lumière, spécialement conçu pour les salles de bains à faible luminosité.
- Miroir rond avec cadre en PMMA, (Polyméthacrylate de méthyle) éclairé.
- Double capteur. On/Off et anti-buée
- Trois types de lumière (chaude 3000K, neutre 4000K et froide 6500K)

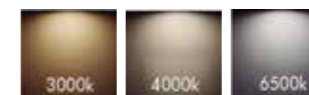

- Espelho com marco iluminado que oferece uma maior quantidade de luz e foi pensado para as casas de banho com menos luz.
- Espelho redondo com marco iluminado em PVC
- Duplo sensor ON/OFF e anti-embaciamento
- 3 tipos de luz (quente 3.000K, neutra 4.000 e fria 6.500K)

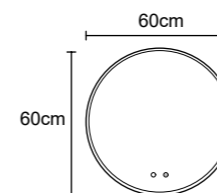

ATEN028/60
Ø 60 cm
Precio: 160€

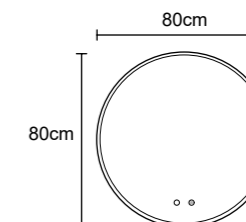

ATEN028/80
Ø 80 cm
Precio: 214€



BOSTON
SERIES





- Espejo con marco totalmente iluminado que aporta una mayor cantidad de luz y que está especialmente concebido para cuartos de baño con poca luminosidad
- Espejo cuadrado con marco iluminado de PVC
- Doble sensor. On/off y anti-vaho
- Tres tipos de luz (cálida 3.000K, neutra 4.000K y fría 6.500K)



- Mirror with fully illuminated frame that provides a greater amount of light and is specially designed for bathrooms with low luminosity.
- Square mirror with illuminated PVC frame.
- Double sensor. On/off and anti-fog
- Three types of light (warm 3.000K, neutral 4.000K and cold 6.500K)



- Miroir avec un cadre entièrement éclairé qui fournit plus de lumière, spécialement conçu pour les salles de bains à faible luminosité.
- Miroir rectangulaire avec cadre en PMMA, (Polyméthacrylate de méthyle) éclairé
- Double capteur. On/Off et anti-buée
- Trois types de lumière (chaude 3000K, neutre 4000K et froide 6500K)



- Espelho com marco iluminado que oferece uma maior quantidade de luz e foi pensado para as casas de banho com menos luz.
- Espelho quadrado com marco iluminado em PVC
- Duplo sensor ON/OFF e anti-embaciamento
- 3 tipos de luz (quente 3.000K, neutra 4.000 e fria 6.500K)

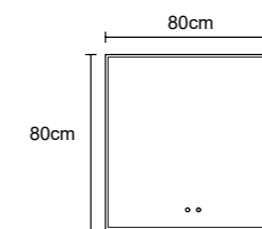
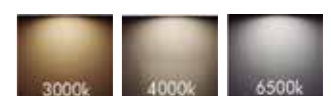

BOST029/80
80 x 80 cm
Precio: 196€

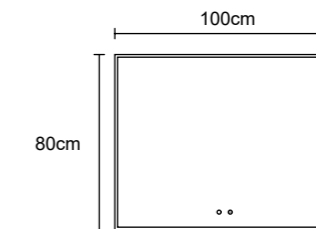

BOST029/100
100 x 80 cm
Precio: 219€

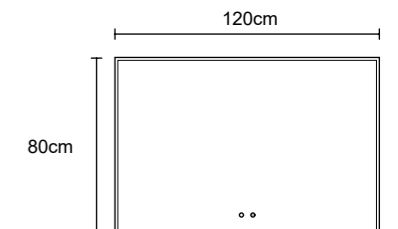

BOST029/120
120 x 80 cm
Precio: 246€



CANADA
SERIES





- Espejo con marco totalmente iluminado que aporta una mayor cantidad de luz y que está especialmente concebido para cuartos de baño con poca luminosidad
- Espejo elíptico con marco iluminado acrílico
- Doble sensor. On/off y antivaho
- Luz fría 6.500K



- Mirror with fully illuminated frame that provides a greater amount of light and is specially designed for bathrooms with low luminosity.
- Elliptical mirror with illuminated acrylic frame
- Double sensor. On/off and anti-fog
- Cold light 6.500K



- Miroir avec cadre entièrement éclairé qui fournit une plus grande quantité de lumière et est spécialement conçu pour les salles de bains à faible luminosité.
- Miroir elliptique avec cadre acrylique
- Double capteur. On/Off et anti-buée
- Lumière froide 6500K



- Espelho com marco totalmente iluminado que aporta uma maior quantidade de luz he pensado para casas de banho com menos luz
- Espelho elíptico com marco iluminado acrílico
- Duplo sensor ON/OFF e anti-embaciamento
- Luz fria de 6.500K

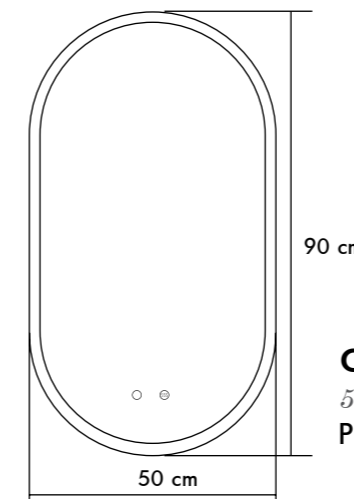

CANA30/90
50 x 90 cm
Precio: 159€



PARIS
SERIES





• Espejo que combina lo simple de un espejo redondo con el valor añadido del marco en aluminio que aporta color y diseño al cuarto de baño
 • Espejo redondo de luz frontal con marco de aluminio disponible en tres acabados, negro mate, PVD oro cepillado y PVD oro rosa cepillado
 • Doble sensor. On/off y antivaho
 • Tres tipos de luz (cálida 3.000K, neutra 4.000K y fría 6.500K)

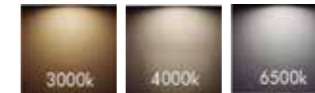

• Mirror that combines the simplicity of a round mirror with the added value of an aluminum frame that brings color and design to the bathroom.
 • Round mirror with front light with aluminum frame available in three finishes, matte black, brushed gold PVD and brushed rose gold PVD.
 • Double sensor. On/off and anti-fog
 • Three types of light (warm 3,000K, neutral 4,000K and cold 6,500K)



• Miroir qui allie la simplicité d'un miroir rond avec la valeur ajoutée d'un cadre en aluminium qui apporte couleur et design à la salle de bains.
 • Miroir rond avec éclairage frontal et cadre en aluminium disponible en trois finitions, noir mat, PVD or brossé et PVD or rose brossé.
 • Double capteur. On/Off et anti-buée
 • Trois types de lumière (chaude 3000K, neutre 4000K et froide 6500K)



• Espelho que combina a simplicidade de um espelho redondo com a mais-valia de uma moldura em alumínio que confere cor e design à casa de banho.
 • Espelho redondo de luz frontal com moldura em alumínio disponível em três acabamentos: preto mate, PVD ouro escovado e PVD ouro rosa escovado.
 • Sensor duplo. On/off e anti-embaciamento
 • Três tipos de luz (quente 3.000K, neutra 4.000K e fria 6.500K)

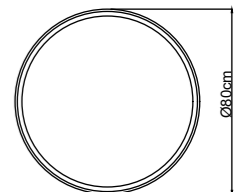
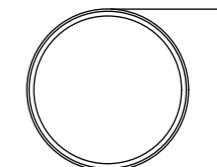
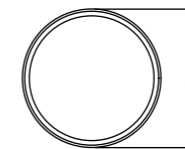

ACABADO FINISH **PARI020/60NG**
 Ø 60 cm
 Precio: 199€

PARI020/70NG
 Ø 70 cm
 Precio: 229€

PARI020/80NG
 Ø 80 cm
 Precio: 259€

ACABADO FINISH **PARI020/60OC**
 Ø 60 cm
 Precio: 199€

PARI020/70OC
 Ø 70 cm
 Precio: 229€

PARI020/80OC
 Ø 80 cm
 Precio: 259€

ACABADO FINISH **PARI020/60OR**
 Ø 60 cm
 Precio: 199€

PARI020/70OR
 Ø 70 cm
 Precio: 229€

PARI020/80OR
 Ø 80 cm
 Precio: 259€



• MATTE BLACK



• BRUSHED GOLD



• BRUSHED ROSE GOLD

SUIZA
SERIES





- Espejo de alta calidad con máximas prestaciones con un marco acabado en aluminio que aporta diseño y calidad al cuarto de baño.
- Espejo cuadrado de luz frontal con marco de aluminio acabado negro mate
- Luz frontal
- Doble sensor. On/off y antivaho
- Tres tipos de luz (cálida 3.000K, neutra 4.000K y fría 6.500K)



- High quality mirror with maximum performance with a frame finished in aluminium that brings design and quality to the bathroom.
- Square mirror with front light with aluminum frame matte black finish.
- Front light.
- Double sensor. On/off and anti-fog
- Three types of light (warm 3.000K, neutral 4.000K and cold 6.500K).



- Miroir de haute qualité aux performances maximales avec un cadre en aluminium noir mat, qui apporte design et qualité à la salle de bains.
- Miroir rectangulaire avec éclairage frontal avec cadre en aluminium finition noir mat
- Eclairage frontal
- Double capteur. On/off et anti-buée
- Trois types de lumière (chaude 3000K, neutre 4000K et froide 6500K).



- Espelho de alta qualidade com o máximo desempenho, com uma moldura com acabamento em alumínio que confere design e qualidade à casa de banho.
- Espelho quadrado com luz frontal e moldura em alumínio com acabamento em preto mate.
- Luz frontal.
- Sensor duplo. On/off e anti-embaciamento.
- Três tipos de luz (quente 3000K, neutra 4000K e fria 6500K).

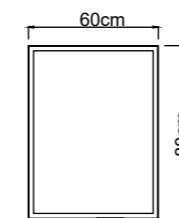

SUIZ010/60NG
60 x 80 cm
Precio: **223€**

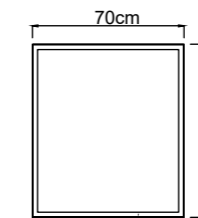

SUIZ010/70NG
70 x 80 cm
Precio: **244€**

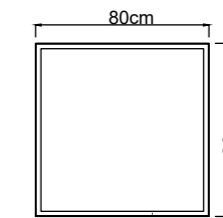

SUIZ010/80NG
80 x 80 cm
Precio: **264€**

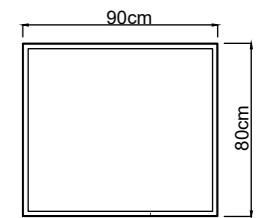

SUIZ010/90NG
90 x 80 cm
Precio: **285€**

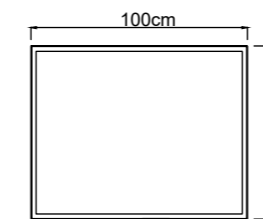

SUIZ010/100NG
100 x 80 cm
Precio: **299€**

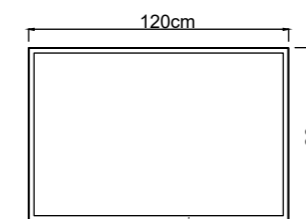

SUIZ010/120NG
120 x 80 cm
Precio: **339€**

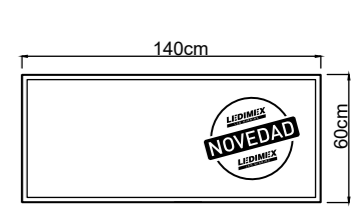

SUIZ010/14060
140 x 60 cm
Precio: **349€**

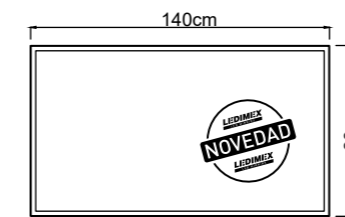

SUIZ010/140NG
140 x 80 cm
Precio: **359€**

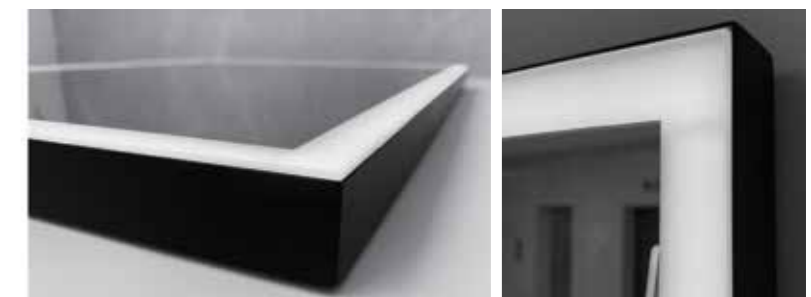

NEW YORK
SERIES





- Espejo rectangular ideal para complementar tu baño con un espejo diferente de lo habitual.
- Espejo rectangular de luz frontal con marco de aluminio disponible en tres acabados, negro mate, PVD oro cepillado y PVD oro rosa cepillado
- Doble sensor. On/off y anti-vaho
- Tres tipos de luz (cálida 3.000K, neutra 4.000K y fría 6.500K)



- Miroir idéal pour compléter votre salle de bains avec un miroir différent de l'habituel.
- Miroir rectangulaire avec éclairage frontal et cadre en aluminium disponible en trois finitions, noir mat, PVD or brossé et PVD or rose brossé.
- Double capteur. On/Off et anti-buée
- Trois types de lumière (chaude 3000K, neutre 4000K et froide 6500K)



- Rectangular mirror ideal to complement your bathroom with a mirror different from the usual.
- Rectangular mirror front light with aluminum frame available in three finishes, matte black, PVD brushed gold and PVD brushed rose gold.
- Double sensor. On/off and anti-fog
- Three types of light (warm 3,000K, neutral 4,000K and cold 6,500K).



- Espelho retangular ideal para complementar a sua casa de banho com um espelho diferente do habitual.
- Espelho retangular com luz frontal com moldura em alumínio disponível em três acabamentos: preto mate, PVD ouro escovado e PVD ouro rosa escovado.
- Sensor duplo. On/off e anti-embaciamento
- Três tipos de luz (quente 3.000K, neutra 4.000K e fria 6.500K)



· MATTE BLACK

NEWY021/160NG

160 x 40 cm

Precio: **279€**



· BRUSHED GOLD

NEWY021/160OC

160 x 40 cm

Precio: **279€**



· BRUSHED ROSE GOLD

NEWY021/160OR

160 x 40 cm

Precio: **279€**

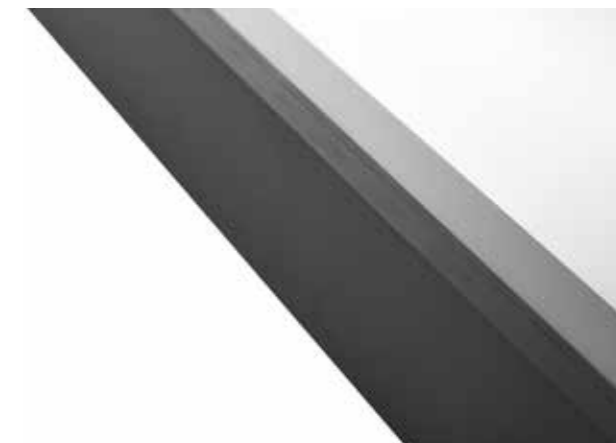



MALTA SERIES



- Espejo práctico y funcional que combina el diseño con la utilidad al incorporar un espejo de aumento.
- Espejo cuadrado de luz frontal con marco perimetral de aluminio
- Doble sensor. On/off y antivaho
- Espejo de aumento x5
- Tres tipos de luz (cálida 3.000K, neutra 4.000K y fría 6.500K)



- Miroir pratique et fonctionnel qui allie design et utilité en incorporant un miroir grossissant.
- Miroir rectangulaire avec éclairage frontal et cadre périmétrique en aluminium.
- Double capteur. On/Off et anti-buée
- Miroir grossissant x5
- Trois types de lumière (chaude 3000K, neutre 4000K et froide 6500K)



- Practical and functional mirror that combines design with utility by incorporating a magnifying mirror.
- Square mirror with front light and aluminum perimeter frame.
- Double sensor. On/off and anti-fog.
- Magnifying mirror x5.
- Three types of light (warm 3,000K, neutral 4,000K and cold 6,500K).



- Espelho prático e funcional que alia o design à utilidade através da incorporação de um espelho de aumento.
- Espelho quadrado com luz frontal e moldura perimetral em alumínio.
- Sensor duplo. On/off e anti-embaciamento.
- Espelho de aumento x5.
- Três tipos de luz (quente 3.000K, neutra 4.000K e fria 6.500K).

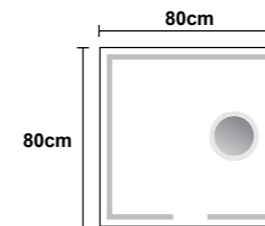

MALT016/80
80 x 80 cm
Precio: **266€**

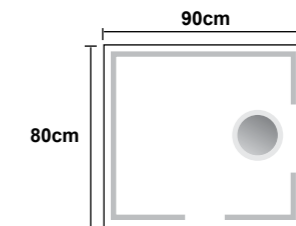

MALT016/90
90 x 80 cm
Precio: **285€**

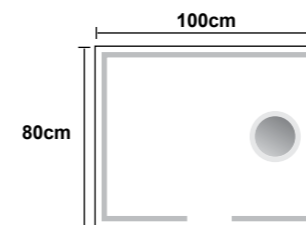

MALT016/100
100 x 80 cm
Precio: **305€**

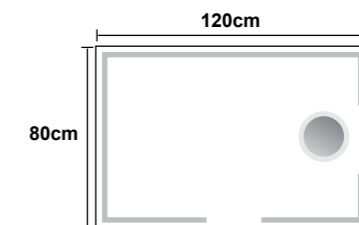

MALT016/120
120 x 80 cm
Precio: **346€**



CONCEPT SERIES





- Espejo práctico y funcional gracias a su sistema de carga wireless para teléfono móvil y su potencia de luz perimetral y frontal
- Espejo cuadrado con cantos redondeados de luz retroiluminada con salida frontal con marco de aluminio en acabado negro mate.
- Estante de aluminio incorporado en el marco.
- Sistema de encendido mediante sensor de movimiento.
- Antivaho incorporado
- Regulable en intensidad manteniendo presionado el sensor
- Cargador Wireless integrado en el estante SIN COSTE ADICIONAL (asegurarse previamente de que el teléfono móvil en cuestión es compatible con la carga inalámbrica)
- Tres tipos de luz (cálida 3.000K, neutra 4.000K y fría 6.500K)

- Practical and functional mirror thanks to its wireless charging system for cell phones and its perimeter and front light power.
- Square mirror with rounded edges of backlight light with front exit with aluminum frame in matte black finish.
- Aluminum shelf incorporated in the frame.
- Motion sensor lighting system.
- Built-in anti-fogging
- Dimmable by pressing and holding the sensor
- Wireless charger integrated in the shelf at NO ADDITIONAL COST (Make sure in advance that the cell phone in question is compatible with wireless charging)
- Three types of light (warm 3,000K, neutral 4,000K and cold 6,500K).



- Miroir pratique et fonctionnel grâce à son système wireless recharge sans fil pour téléphones portables, avec son éclairage périmétrique et frontal.
- Miroir carré aux bords contour arrondis avec lumière rétroéclairée et sortie frontale avec cadre en aluminium en finition noir mat.
- Tablette en aluminium incorporée dans le cadre.
- Système de commutation par capteur de mouvement.
- Anti-buée intégré.
- Intensité variable par pression et maintien du capteur.
- Chargeur sans fil intégré à la tablette SANS FRAIS SUPPLÉMENTAIRES (assurez-vous au préalable que le téléphone portable en question est compatible avec la recharge sans fil)
- Trois types de lumière (chaude 3000 K, neutre 4000 K et froide 6500 K).

- Espelho prático e funcional graças ao sistema de carregamento wireless para telemóvel e a potencia de luz perimetral e frontal
- Espelho quadrado com cantos redondos de luz retroiluminada frontal, marco de alumínio e acabamento preto mate
- Estante de alumínio incorporada no marco.
- Sistema de ligação mediante sensor de movimento.
- Anti-embaciamento integrado
- Ajustável em intensidade pressionando o sensor
- Carregador Wireless integrado no marco SEM CUSTOS ADICIONAL (atenção previa verificação se o dispositivo é compatível com o carregador).
- 3 tipos de luz (quente 3.000K, neutra 4.000 e fria 6.500K)



- Cargador Wireless integrado en el estante SIN COSTE ADICIONAL.
- Wireless charger integrated in the shelf at NO ADDITIONAL COST.
- Chargeur sans fil intégré à la tablette SANS FRAIS SUPPLÉMENTAIRES.
- Carregador Wireless integrado no marco SEM CUSTOS ADICIONAL.

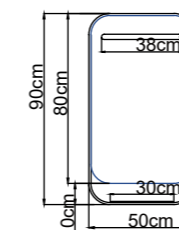

CONC032/50NG
50 x 90 cm
Precio: 272€

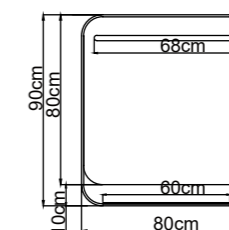

CONC032/80NG
80 x 90 cm
Precio: 316€

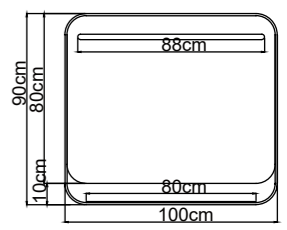

CONC032/100NG
100 x 90 cm
Precio: 332€

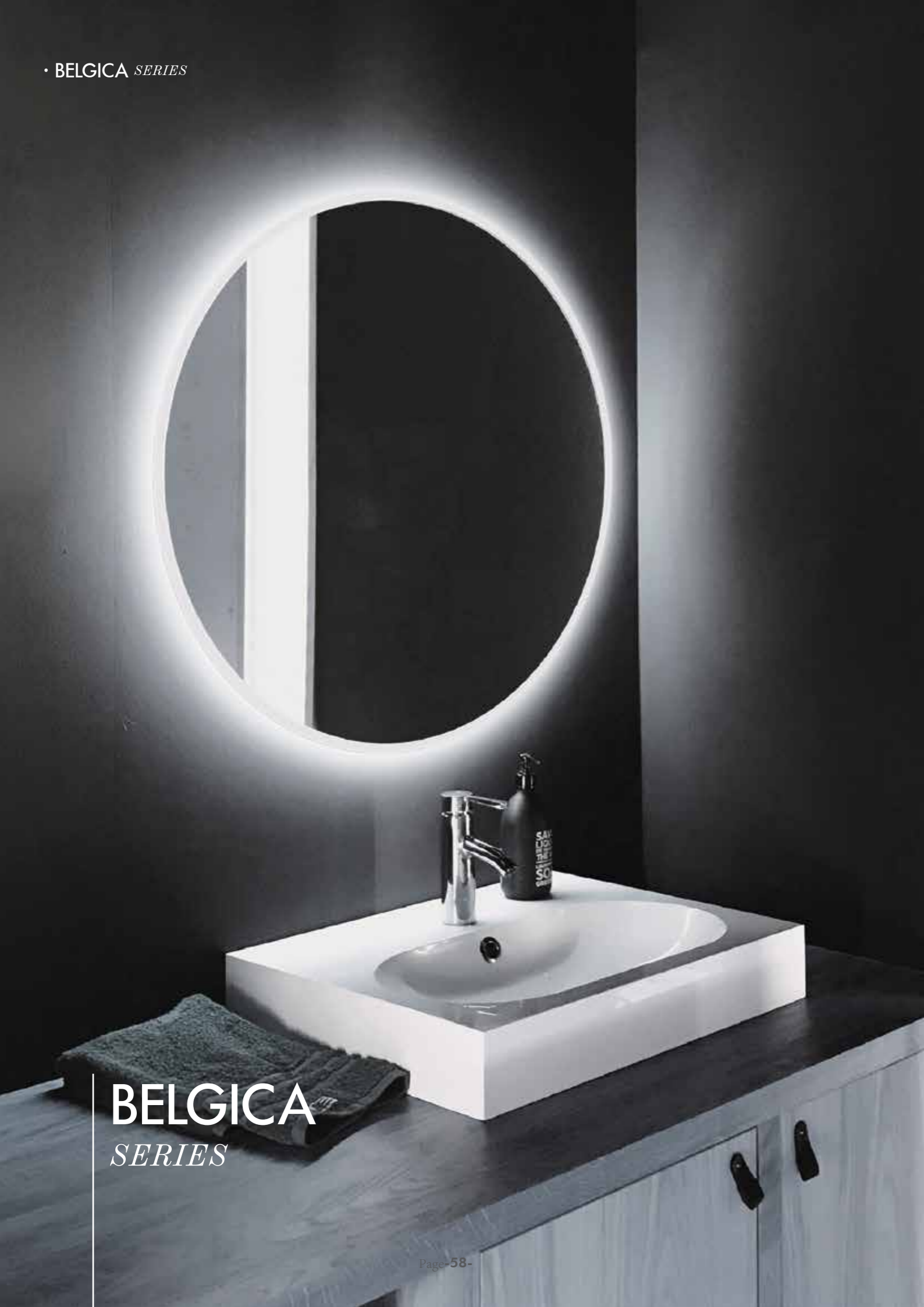

BELGICA
SERIES



• Espejo redondo de luz retroiluminada con salida frontal a través de arenado en el cristal
• Luz fría 6.500K



• Round mirror with backlight light with front exit through sandblasting on the glass
• Cold light 6.500K



• Miroir rond avec lumière rétro-éclairée avec sortie frontale par sablage dans le verre
• Lumière froide 6500K



• Espelho redondo com luz de fundo com saída frontal em vidro jato de areia
• Luz fria 6.500K



50cm

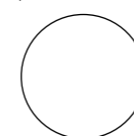

BELG003/50

Ø 50 cm

Precio: **129€**

60cm

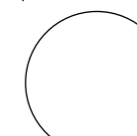

BELG003/60

Ø 60 cm

Precio: **138€**

70cm

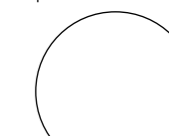

BELG003/70

Ø 70 cm

Precio: **160€**

80cm

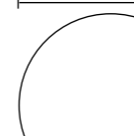

BELG003/80

Ø 80 cm

Precio: **174€**

90cm

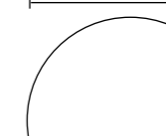

BELG003/90

Ø 90 cm

Precio: **202€**

100cm

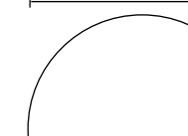

BELG003/100

Ø 100 cm

Precio: **234€**

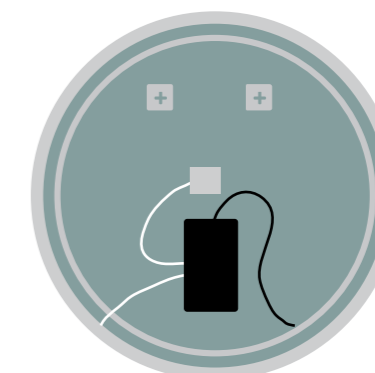
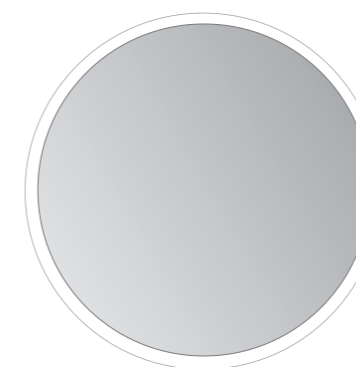



• Espejo redondo de luz retroiluminada con salida frontal a través de arenado en el cristal
 • Doble sensor. On/off y antivaho
 • Luz fría 6.500K



• Round mirror with backlight light with frontal exit through sandblasted glass.
 • Double sensor. On/off and anti-fog
 • Cold light 6.500K



• Miroir rond rétro-éclairé avec sortie frontale par le verre sablé.
 • Double capteur. On/Off et anti-buée
 • Lumière froide 6500K



• Espelho redondo com luz de fundo com saída frontal em vidro jato de areia
 • Sensor duplo. On/off e anti-embaciamento
 • Luz fria 6.500K

50cm

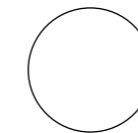

LOND004/50

Ø 50 cm

Precio: **162€**

60cm

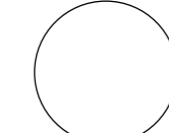

LOND004/60

Ø 60 cm

Precio: **192€**

70cm

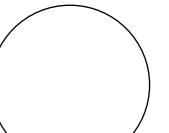

LOND004/70

Ø 70 cm

Precio: **225€**

80cm



LOND004/80

Ø 80 cm

Precio: **246€**

90cm

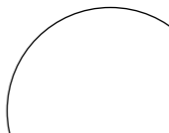

LOND004/90

Ø 90 cm

Precio: **272€**

100cm

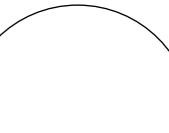

LOND004/100

Ø 100 cm

Precio: **290€**

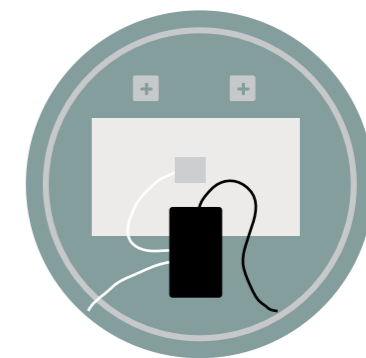
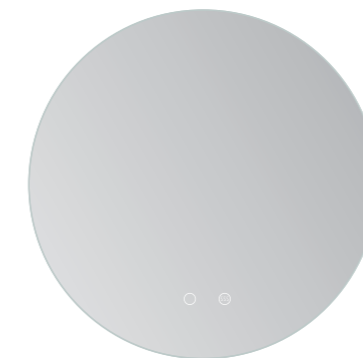

LONDRES
 SERIES



FRANCIA SERIES



• Espejo cuadrado de luz retroiluminada con salida frontal a través de arenado en el cristal
• Luz fría 6.500K



• Square mirror with backlight light with front exit through sandblasting in the glass
• Cold light 6,500K



• Miroir rectangulaire avec lumière rétro-éclairée avec sortie frontale à travers le verre sablé
• Lumière froide 6500K



• Espelho retroiluminado quadrado com saída frontal através de vidro jato de areia
• Luz fria 6.500K

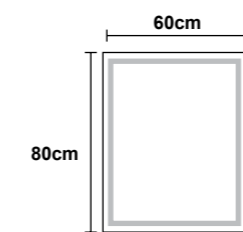

FRANC008/60
60 x 80 cm
Precio: **163€**

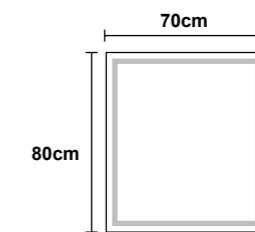

FRANC008/70
70 x 80 cm
Precio: **173€**

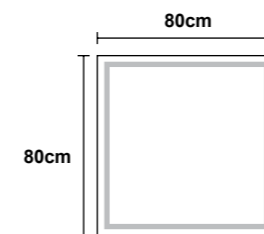

FRANC008/80
80 x 80 cm
Precio: **185€**

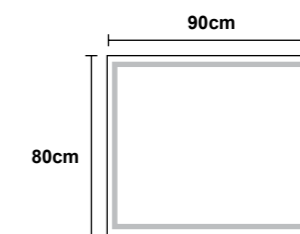

FRANC008/90
90 x 80 cm
Precio: **220€**

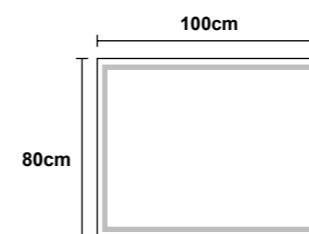

FRANC008/100
100 x 80 cm
Precio: **232€**

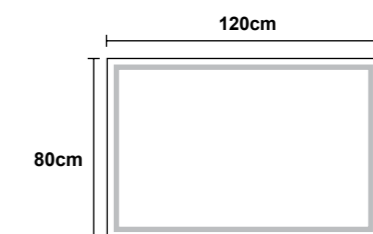

FRANC008/120
120 x 80 cm
Precio: **299€**

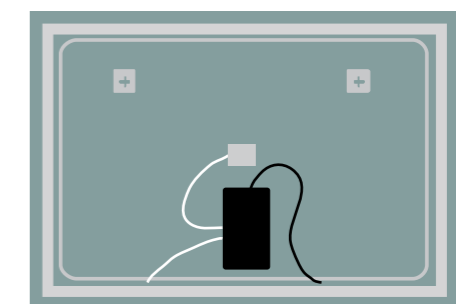

HOLANDA

SERIES



- Espejo cuadrado de luz retroiluminada con salida frontal a través de arenado en el cristal
- Doble sensor. On/off y antivaho
- Luz fría 6.500K



- Square mirror with backlight light with frontal exit through sandblasted glass.
- Double sensor. On/off and anti-fog
- Cold light 6.500K



- Miroir rectangulaire avec lumière rétro-éclairé avec sortie frontale à travers le verre sablé.
- Double capteur. On/Off et anti-buée
- Lumière froide 6500K



- Espelho retroiluminado quadrado com saída frontal através de vidro jato de areia
- Sensor duplo. On/off e anti-embaciamento
- Luz fria 6.500K

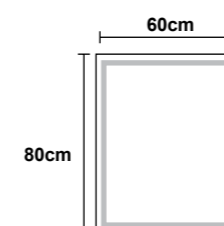

HOLAN009/60
60 x 80 cm
Precio: **217€**

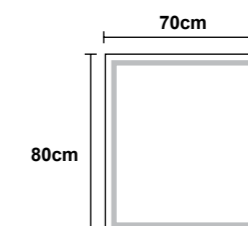

HOLAN009/70
70 x 80 cm
Precio: **227€**

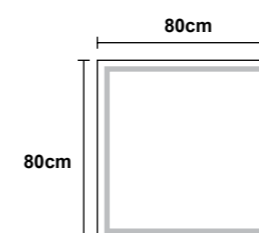

HOLAN009/80
80 x 80 cm
Precio: **237€**

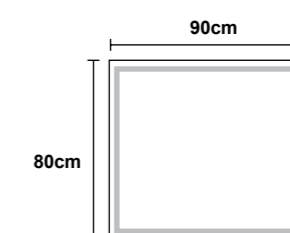

HOLAN009/90
90 x 80 cm
Precio: **264€**

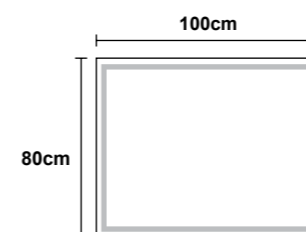

HOLAN009/100
100 x 80 cm
Precio: **283€**

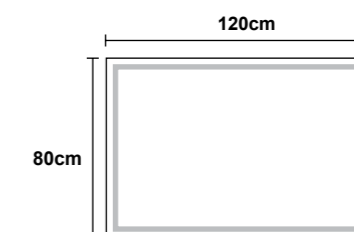

HOLAN009/120
120 x 80 cm
Precio: **312€**

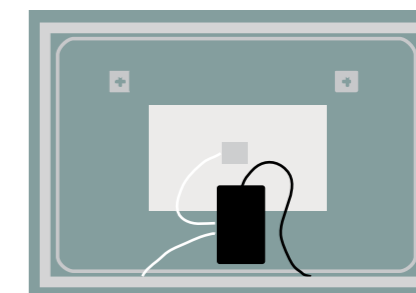

AUSTRIA

SERIES



• Espejo cuadrado con cantos redondeados de luz retroiluminada con salida frontal a través de arenado en el cristal
 • Luz fría 6.500K



• Square mirror with rounded edges of backlight light with frontal exit through sandblasted glass.
 • Cold light 6,500K



• Miroir rectangulaire aux bords arrondis avec lumière rétro-éclairée avec sortie frontale par sablage dans le verre
 • Lumière froide 6500K



• Espelho quadrado com cantos arredondados de luz de fundo com saída frontal através de jato de areia no vidro
 • Luz fria 6.500K

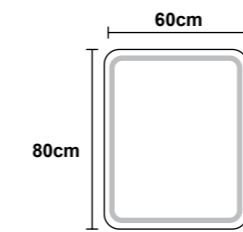

AUST012/60
 60 x 80 cm
 Precio: **181€**

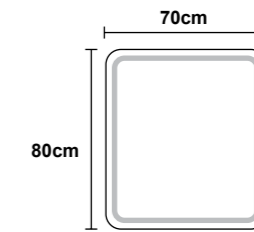

AUST012/70
 70 x 80 cm
 Precio: **209€**

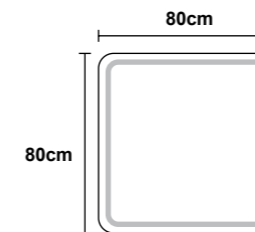

AUST012/80
 80 x 80 cm
 Precio: **229€**

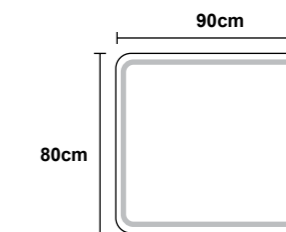

AUST012/90
 90 x 80 cm
 Precio: **257€**

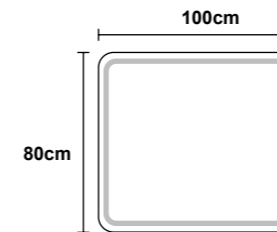

AUST012/100
 100 x 80 cm
 Precio: **278€**

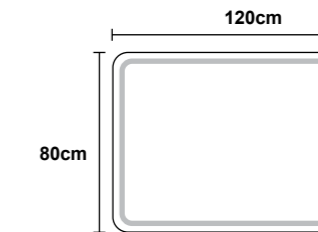

AUST012/120
 120 x 80 cm
 Precio: **316€**

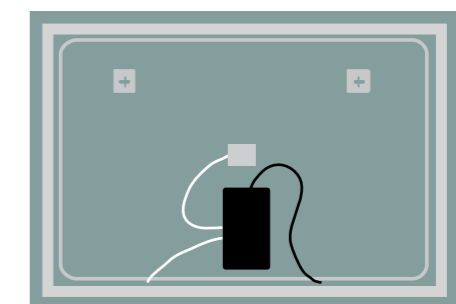



GRECIA

SERIES



• Espejo cuadrado con cantos redondeados de luz retroiluminada con salida frontal a través de arenado en el cristal
 • Doble sensor. On/off y antivaho
 • Luz fría 6.500K



• Square mirror with rounded edges of backlight light with frontal exit through sandblasted glass.
 • Double sensor. On/off and anti-fog
 • Cold light 6.500K



• Miroir rectangulaire aux bords arrondis avec lumière rétro-éclairée et sortie frontale à travers le verre sablé.
 • Double capteur. On/Off et anti-buée
 • Lumière froide 6500K



• Espelho quadrado com cantos arredondados de luz de fundo com saída frontal através de jato de areia no vidro
 • Sensor duplo. On/off e anti-embaciamento
 • Luz fria 6.500K

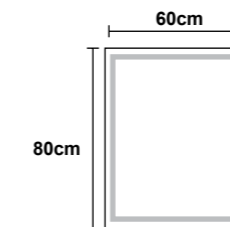

GREC013/60
 60 x 80 cm
 Precio: **219€**

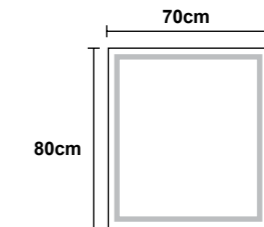

GREC013/70
 70 x 80 cm
 Precio: **229€**

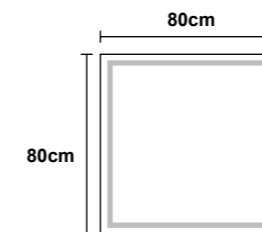

GREC013/80
 80 x 80 cm
 Precio: **249€**

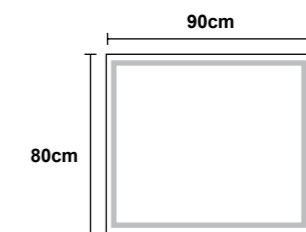

GREC013/90
 90 x 80 cm
 Precio: **265€**

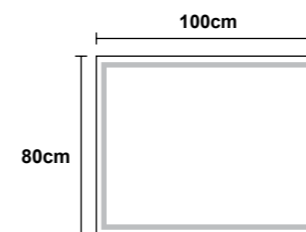

GREC013/100
 100 x 80 cm
 Precio: **285€**

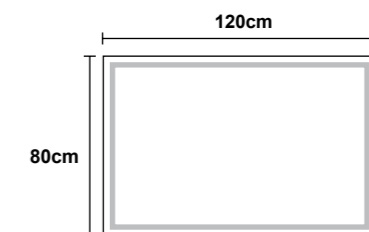

GREC013/120
 120 x 80 cm
 Precio: **327€**

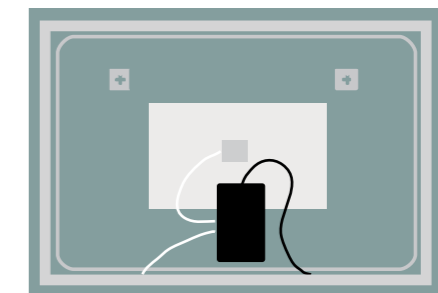



PRAGA SERIES



• Espejo cuadrado con cantos redondeados de luz retroiluminada con salida frontal a través de arenado en el cristal
 • Doble sensor. On/off y antivaho
 • Luz fría 6.500K



• Square mirror with rounded edges of backlight light with front exit through sandblasted glass.
 • Double sensor. On/off and anti-fog
 • Cold light 6.500K



• Miroir rectangulaire aux bords arrondis avec lumière rétro-éclairée et sortie frontale à travers le verre sablé.
 • Double capteur. On/Off et anti-buée
 • Lumière froide 6500K



• Espelho quadrado com cantos arredondados de luz de fundo com saída frontal através de vidro jato de areia.
 • Sensor duplo. On/off e anti-embaciamento
 • Luz fria 6.500K

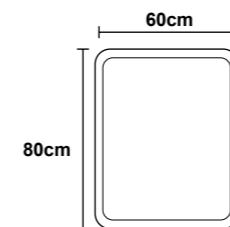

PRAG014/60
 60 x 80 cm
 Precio: **215€**

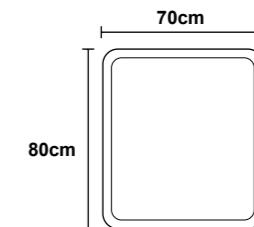

PRAG014/70
 70 x 80 cm
 Precio: **224€**

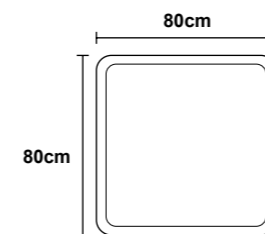

PRAG014/80
 80 x 80 cm
 Precio: **243€**

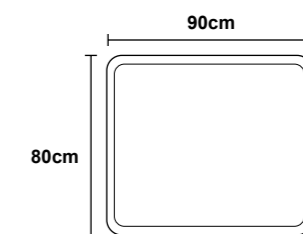

PRAG014/90
 90 x 80 cm
 Precio: **253€**

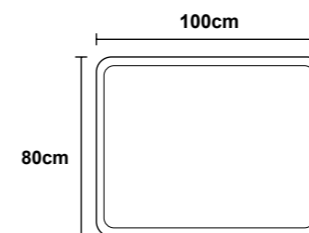

PRAG014/100
 100 x 80 cm
 Precio: **272€**

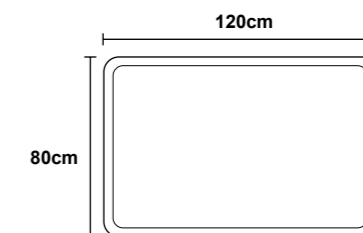

PRAG014/120
 120 x 80 cm
 Precio: **322€**

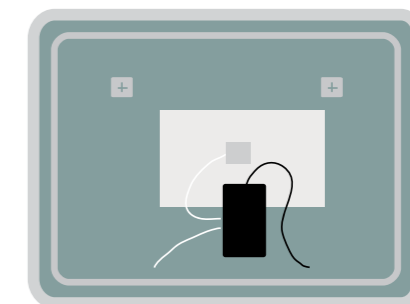

TOKYO
SERIES





- Espejo diseñado para aquellos que quieren hacer de su cuarto de baño un ambiente único.
- Espejo elíptico de luz retroiluminada con marco de aluminio disponible en 3 acabados, Negro mate, PVD oro cepillado y PVD Oro rosa cepillado
- Doble sensor. On/off y antivaho
- Tres tipos de luz (cálida 3.000K, neutra 4.000K y fría 6.500K)

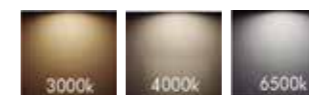

- Mirror designed for those who want to make their bathroom a unique environment.
- Elliptical mirror with backlight light with aluminum frame available in 3 finishes, Matte Black, PVD Brushed Gold and PVD Brushed Rose Gold.
- Double sensor. On/off and anti-fog
- Three types of light (warm 3,000K, neutral 4,000K and cold 6,500K).



- Miroir conçu pour ceux qui veulent donner à leur salle de bains une atmosphère unique.
- Miroir elliptique avec lumière rétro-éclairée et cadre en aluminium disponible en 3 finitions, noir mat, PVD or brossé et PVD or rose brossé.
- Double capteur. On/Off et anti-buée
- Trois types de lumière (chaude 3000K, neutre 4000K et froide 6500K).



- Espelho concebido para quem pretende tornar a sua casa de banho num ambiente único.
- Espelho elíptico retroiluminado com moldura em alumínio disponível em 3 acabamentos: preto mate, PVD ouro escovado e PVD ouro rosa escovado.
- Sensor duplo. On/off e anti-embaciamento
- Três tipos de luz (quente 3000K, neutra 4000K e fria 6500K).



• MATTE BLACK

TOKY022/90NG

50 x 90 cm

Precio: **219€**



• BRUSHED GOLD

TOKY022/90OC

50 x 90 cm

Precio: **219€**



• BRUSHED ROSE GOLD

TOKY022/90OR

50 x 90 cm

Precio: **219€**

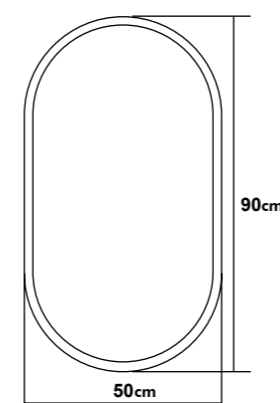

CARDIFF & GALES *SERIES*



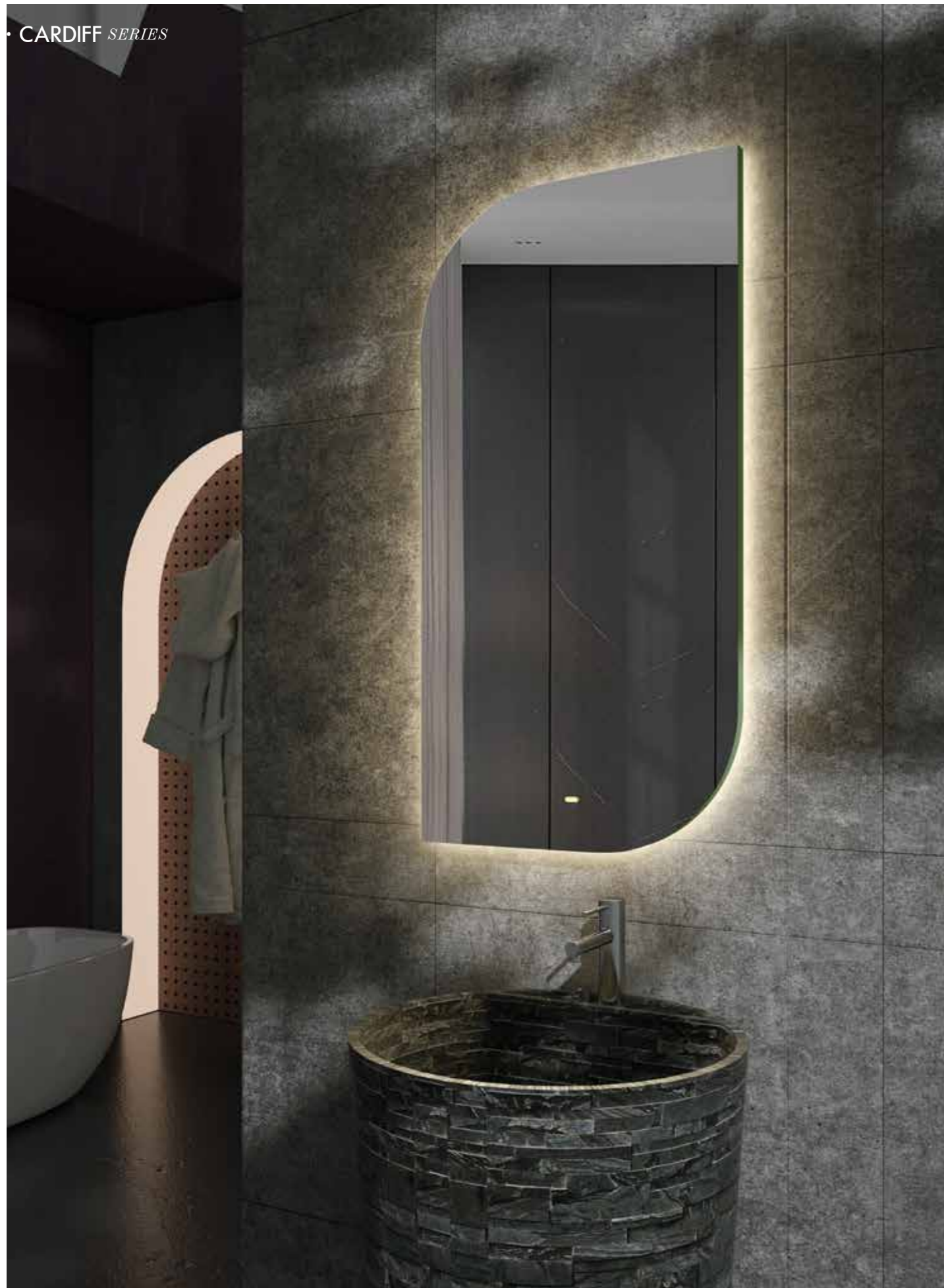

• CARDIFF SERIE



- Espejo con sistema de encendido mediante sensor de movimiento ideado especialmente para no tener que tocar el espejo.
- Espejo rectangular con dos esquinas en acabado redondo y dos esquinas en acabado cuadrado de luz retroiluminada
- Con sistema de encendido mediante sensor de movimiento
- Antivaho incorporado
- Luz cálida 3.000K



- Mirror with motion sensor lighting system specially designed to avoid having to touch the mirror.
- Rectangular mirror with two corners in round finish and two corners in square finish with backlight light.
- With motion-sensor switch-on system
- Built-in anti-fogging
- Warm light 3.000K



- Miroir avec système d'éclairage par détecteur de mouvement spécialement conçu pour éviter de toucher le miroir.
- Miroir rectangulaire avec deux angles en finition ronde et deux angles en finition carrée avec lumière rétro-éclairée.
- Avec système d'allumage par détecteur de mouvement
- Anti-buée intégré
- Lumière chaude 3000K



- Espelho com sistema de ligação mediante sensor de movimento criado para não tocar no espelho
- Espelho retangular com 2 esquinas em acabamento redondo e as otras 2 quadradas com luz retroiluminada
- Com sistema de ligação mediante sensor de movimento
- Anti-embaciamento integrado
- Luz quente 3.000K

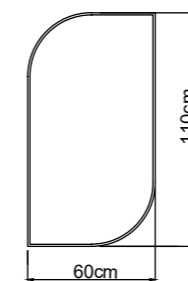

CARD023/11060
60 x 110 cm
Precio: 202€

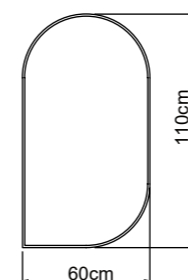

GALE024/11060
60 x 110 cm
Precio: 202€

• GALES SERIE



- Espejo con sistema de encendido mediante sensor de movimiento ideado especialmente para no tener que tocar el espejo.
- Espejo ovalado con una esquina acabada en ángulo recto de luz retroiluminada
- Con sistema de encendido mediante sensor de movimiento
- Antivaho incorporado
- Luz fría 6.500K



- Mirror with motion sensor lighting system specially designed to avoid having to touch the mirror.
- Oval mirror with one corner finished in right angle backlight light.
- With motion sensor switch-on system
- Built-in anti-fogging
- Cold light 6,500K



- Miroir avec système d'éclairage par détecteur de mouvement spécialement conçu pour éviter de toucher le miroir.
- Miroir ovale avec angle droit et lumière rétroéclairée.
- Avec système d'allumage par détecteur de mouvement
- Anti-buée intégré
- Lumière froide 6500



- Espelho com sistema de ligação mediante sensor de movimento pensado para não tocar no espelho.
- Espelho ovalado com uma esquina acabada em angulo reto de luz retroiluminada
- Anti-embaciamento integrado
- Luz fria de 6.500K



FUN
SERIES





- Espejo que combina lo simple de un espejo redondo retroiluminado con el valor añadido del marco en aluminio que aporta color y diseño al cuarto de baño
- Espejo redondo de luz retroiluminada con marco en aluminio disponible en dos colores, negro mate y PVD oro cepillado
- Doble sensor. On/off y antivaho
- Tres tipos de luz (cálida 3.000K, neutra 4.000K y fría 6.500K)



- Mirror that combines the simplicity of a round backlight mirror with the added value of an aluminum frame that brings color and design to the bathroom.
- Round backlight mirror with aluminum frame available in two colors, matte black and brushed gold PVD.
- Double sensor. On/off and anti-fog
- Three types of light (warm 3.000K, neutral 4.000K and cold 6.500K)



- Miroir qui allie la simplicité d'un miroir rond rétro-éclairé à la valeur ajoutée d'un cadre en aluminium qui apporte couleur et design à la salle de bains.
- Miroir rond rétro-éclairé avec cadre en aluminium disponible en deux couleurs, noir mat et PVD or brossé.
- Double capteur. On/Off et anti-buée
- Trois types de lumière (chaude 3000 K, neutre 4000 K et froide 6500 K).



- Espelho que combina a simplicidade de um espelho redondo retroiluminado com o valor de um marco que aporta cor e desenho à casa de banho.
- Espelho redondo de luz retroiluminada no marco em alumínio disponível em 2 acabamentos, preto mate e ouro mate.
- Duplo sensor ON/OFF e anti-embaciamento
- 3 tipos de luz (quente 3.000K, neutra 4.000 e fria 6.500K)

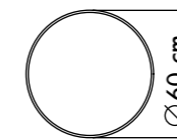

ACABADO FINISH **FUN026/60NG**
 Ø 60 cm
 Precio: **207€**

ACABADO FINISH **FUN026/60OC**
 Ø 60 cm
 Precio: **207€**

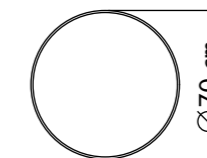

FUN026/70NG
 Ø 70 cm
 Precio: **236€**

FUN026/70OC
 Ø 70 cm
 Precio: **236€**

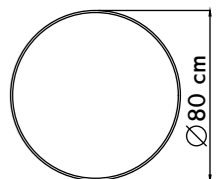

FUN026/80NG
 Ø 80 cm
 Precio: **267€**

FUN026/80OC
 Ø 80 cm
 Precio: **267€**



• MATTE BLACK



• BRUSHED GOLD

CALIFORNIA

SERIES





- Espejo decorativo retroiluminado enmarcado en acero inoxidable en tres acabados con cristal superpuesto en el marco.
- Espejo cuadrado de luz retroiluminada con marco de acero inoxidable disponible en 3 acabados. Negro mate, PVD Black gun metal y PVD Oro cepillado
- Doble sensor. On/off y antivaho
- Tres tipos de luz (cálida 3.000K, neutra 4.000K y fría 6.500K)



- Decorative backlight mirror framed in stainless steel in three finishes with glass superimposed on the frame.
- Square backlight mirror with stainless steel frame available in 3 finishes. Matte black, PVD Black gun metal and PVD brushed gold.
- Double sensor. On/off and anti-fog
- Three types of light (warm 3,000K, neutral 4,000K and cold 6,500K).



- Miroir décoratif avec un encadrement en aluminium, dans trois finitions avec verre superposé sur le cadre.
- Miroir rectangulaire, rétro-éclairé, disponible en 3 finitions. Noir mat, PVD Black gun metal et PVD or brossé.
- Double capteur. On/Off et anti-buée
- Trois types de lumière (chaude 3000 K, neutre 4000 K et froide 6500 K).



- Espelho decorativo retroiluminado marco em aço inoxidável em 3 acabamentos com vidro sobre o marco.
- Acabamentos preto mate/black gun metal PVD/ Ouro mate PVD
- Duplo sensor ON/OFF e anti-embaciamento
- 3 tipos de luz (quente 3.000K, neutra 4.000 e fria 6.500K)

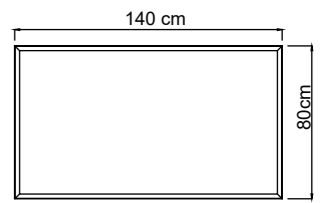
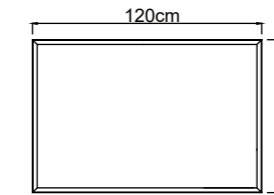
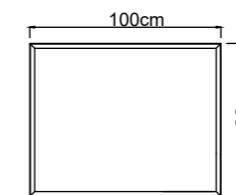

ACABADO FINISH **CALI034/100BGM**
100 x 80 cm
Precio: **246€**

CALI034/120BGM
120 x 80 cm
Precio: **281€**

CALI034/140BGM
140 x 80 cm
Precio: **305€**

ACABADO FINISH **CALI034/100NG**
100 x 80 cm
Precio: **246€**

CALI034/120NG
120 x 80 cm
Precio: **281€**

CALI034/140NG
140 x 80 cm
Precio: **305€**

ACABADO FINISH **CALI034/100OC**
100 x 80 cm
Precio: **246€**

CALI034/120OC
120 x 80 cm
Precio: **281€**

CALI034/140OC
140 x 80 cm
Precio: **305€**



· BLACK GUN METAL



· MATTE BLACK



· BRUSHED GOLD

Oporto
SERIES





- Espejo sencillo y práctico ideal para cualquier cuarto de baño
- Espejo redondo de luz retroiluminada
- Luz fría (6.500K) ó Luz cálida (3.000K)



- Miroir simple et pratique, idéal pour toute les salle de bains.
- Miroir rond avec lumière rétro-éclairée
- Lumière froide (6500K) ou chaude (3000K).



- Simple and practical mirror ideal for any bathroom.
- Round mirror with backlight light
- Cold light (6.500K) or Warm light (3.000K)



- Espelho simples e práctico ideal para qualquer casa de banho.
- Espelho redondo com luz de fundo
- Luz fria (6.500K) ou luz quente (3.000K)



• 6500 °K COLD LIGHT



• 3000 °K WARM LIGHT

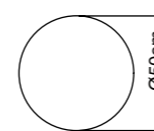

OPOR001/50
Ø 50 cm
Precio: **115€**

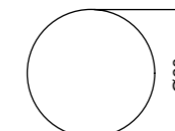

OPOR001/60
Ø 60 cm
Precio: **122€**

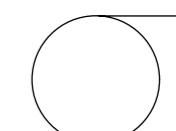

OPOR001/60C
Ø 60 cm
Precio: **122€**

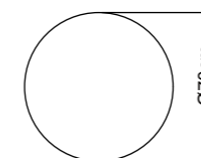

OPOR001/70
Ø 70 cm
Precio: **138€**

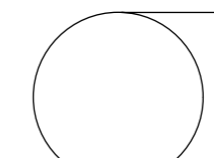

OPOR001/80
Ø 80 cm
Precio: **151€**

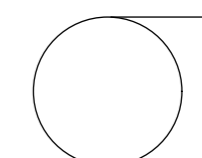

OPOR001/70C
Ø 70 cm
Precio: **138€**

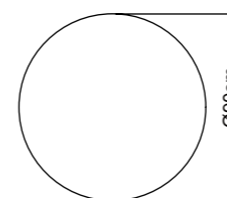

OPOR001/90
Ø 90 cm
Precio: **165€**

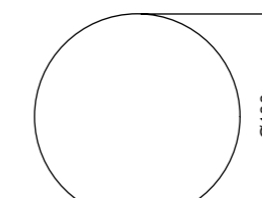

OPOR001/100
Ø 100 cm
Precio: **210€**

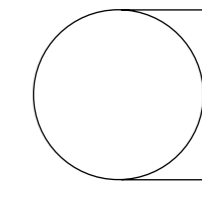

OPOR001/80C
Ø 80 cm
Precio: **151€**





LISBOA
SERIES

- Espejo redondo de luz retroiluminada
- Doble sensor. On/off y antivaho
- Luz fría 6.500K

- Round mirror with backlight light.
- Double sensor. On/off and anti-fog
- Cold light 6.500K

- Miroir rond avec lumière rétro-éclairée.
- Double capteur. On/Off et anti-buée
- Lumière froide 6500K

- Espelho redondo com luz de fundo.
- Sensor duplo. On/off e anti-embaciamento
- Luz fria 6.500K



50cm

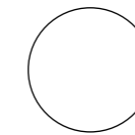

LISB002/50
Ø 50 cm
Precio: **169€**

60cm

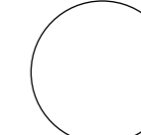

LISB002/60
Ø 60 cm
Precio: **179€**

70cm

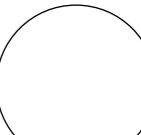

LISB002/70
Ø 70 cm
Precio: **209€**

80cm

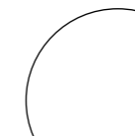

LISB002/80
Ø 80 cm
Precio: **239€**

90cm



LISB002/90
Ø 90 cm
Precio: **274€**

100cm

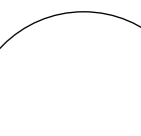

LISB002/100
Ø 100 cm
Precio: **290€**

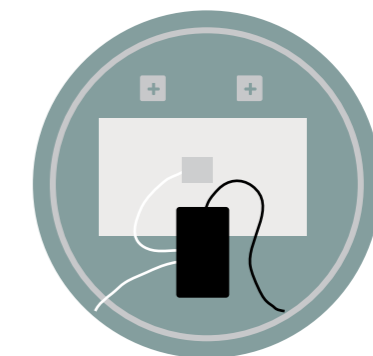

SUECIA
SERIES





- Espejo sencillo y práctico ideal para cualquier cuarto de baño
- Espejo cuadrado de luz retroiluminada
- Luz fría 6.500K



- Simple and practical mirror, ideal for any bathroom.
- Square mirror with backlight light
- Cold light 6.500K



- Miroir simple et pratique, idéal pour toute salle de bains.
- Miroir carré avec lumière rétro-éclairée
- Lumière froide 6500K



- Espelho simples e práctico ideal para qualquer casa de banho.
- Espelho quadrado com luz de fundo
- Luz fria 6.500K

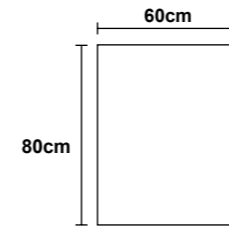

SUEC006/60
60 x 80 cm
Precio: **179€**

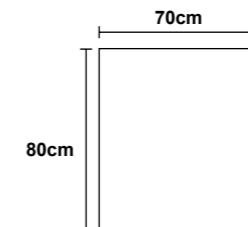

SUEC006/70
70 x 80 cm
Precio: **189€**

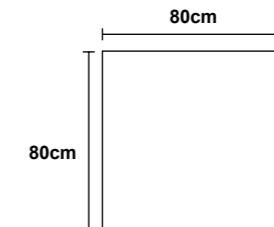

SUEC006/80
80 x 80 cm
Precio: **209€**

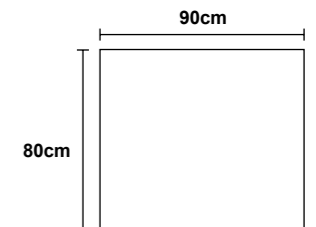

SUEC006/90
90 x 80 cm
Precio: **229€**

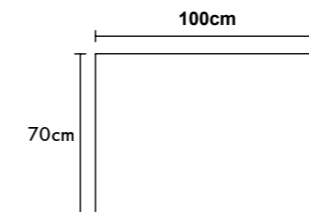

SUEC006/10070
100 x 70 cm
Precio: **249€**

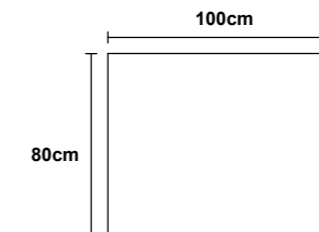

SUEC006/100
100 x 80 cm
Precio: **269€**

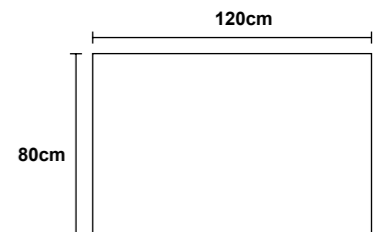

SUEC006/120
120 x 80 cm
Precio: **289€**

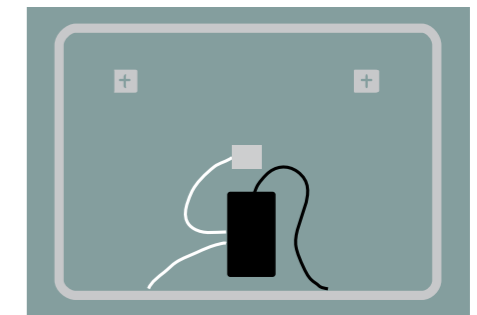

ITALIA

SERIES





- Espejo cuadrado de luz retroiluminada
- Doble sensor. On/off y antivaho
- Luz fría 6.500K



- Square mirror with backlight light.
- Double sensor. On/off and anti-fog
- Cold light 6.500K



- Miroir rectangulaire avec lumière rétro-éclairée.
- Double capteur. On/Off et anti-buée
- Lumière froide 6500K



- Espelho quadrado com luz de fundo.
- Sensor duplo. On/off e anti-embaçamento
- Luz fria 6.500K

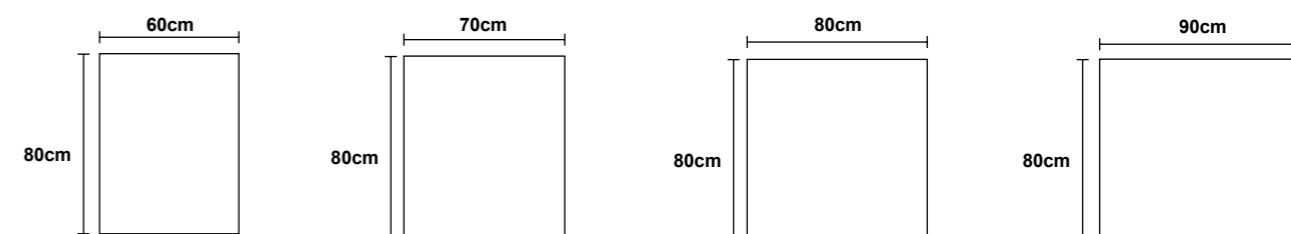

ITAL007/60
60 x 80 cm
Precio: 190€

ITAL007/70
70 x 80 cm
Precio: 219€

ITAL007/80
80 x 80 cm
Precio: 239€

ITAL007/90
90 x 80 cm
Precio: 259€

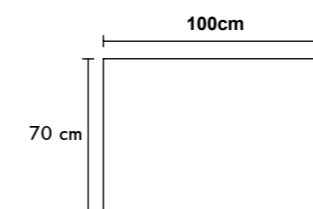

ITAL007/10070
100 x 80 cm
Precio: 269€

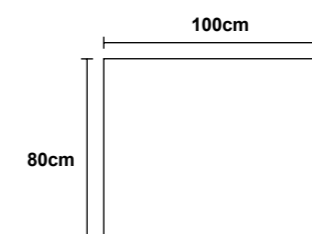

ITAL007/100
100 x 80 cm
Precio: 279€

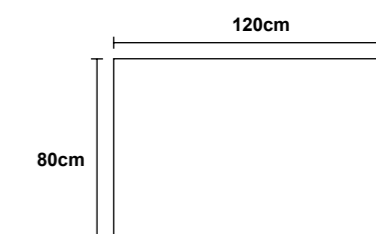

ITAL007/120
120 x 80 cm
Precio: 299€

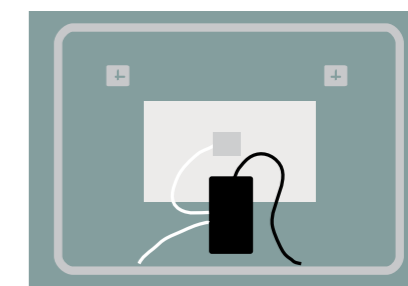
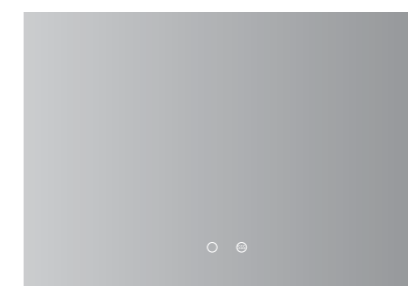

DINAMARCA

SERIES



• Espejo cuadrado con cantos redondeados de luz retroiluminada
• Luz fría 6.500K



• Square mirror with rounded edges with backlight light.
• Cold light 6.500K



• Miroir rectangulaire aux bords arrondis avec lumière rétro-éclairée
• Lumière froide 6500K



• Espelho quadrado com cantos arredondados com luz de fundo
• Luz fria 6.500K

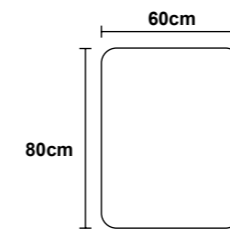

DINA011/60
60 x 80 cm
Precio: **186€**

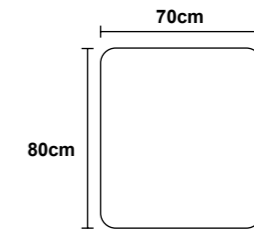

DINA011/70
70 x 80 cm
Precio: **199€**

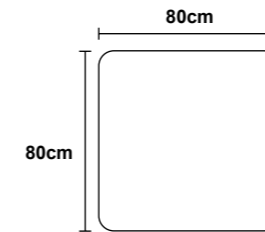

DINA011/80
80 x 80 cm
Precio: **229€**

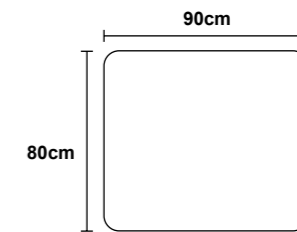

DINA011/90
90 x 80 cm
Precio: **249€**

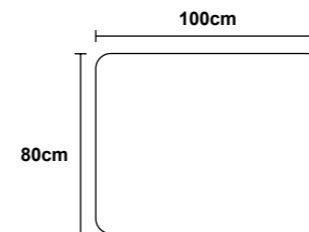

DINA011/100
100 x 80 cm
Precio: **279€**

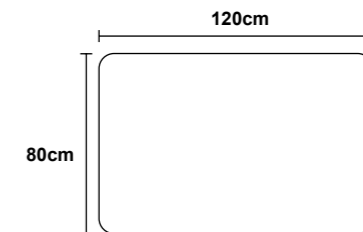

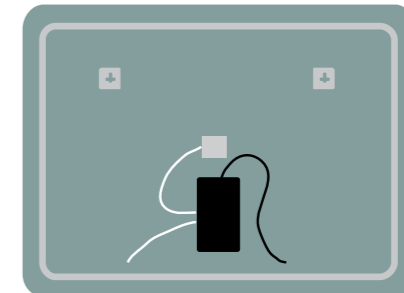

DINA011/120
120 x 80 cm
Precio: **303€**





 · Espejo ovalado de luz retroiluminada.
· Luz fría 6.500K.

 · Oval mirror with backlight light.
· Cold light 6.500K.

 · Miroir ovale avec lumière rétro-éclairée.
· Lumière froide 6500K.

 · Espelho oval com luz de fundo
· Luz fria 6.500K

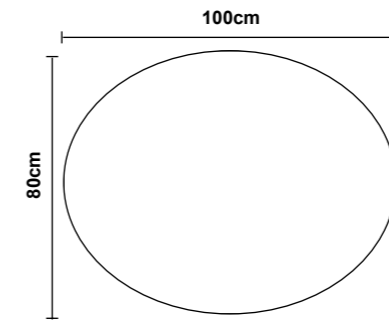

OVAL019/100
100 x 80 cm
Precio: **234€**

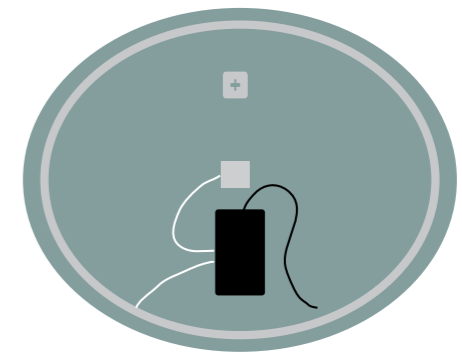
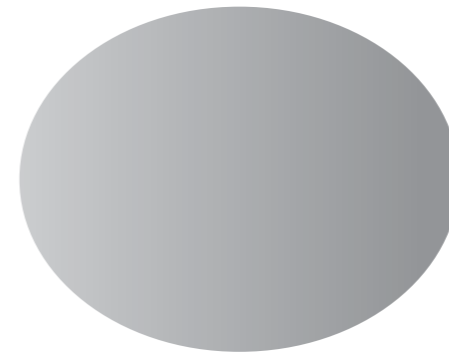

OVAL
SERIES

Instrucciones de montaje

Espejos cuadrados o redondos

Antes de comenzar, comprobar que disponemos de todas las herramientas necesarias para la instalación.



Nivel



Lápiz



Destornillador



Taladro con broca 8mm



Cinta métrica

Vídeo instrucciones de montaje:



01 Compruebe que todas las piezas estén presentes consultando las instrucciones de instalación.

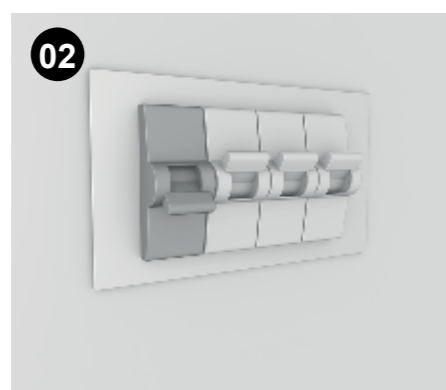

02 Corte la conexión eléctrica de la zona donde va a realizar la instalación y verifique el nivel de voltaje.

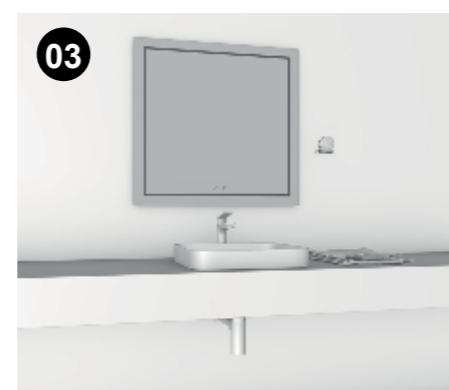

03 Coloque el espejo en la posición deseada, identifique y marque los puntos de anclaje.



04 Los espejos iluminados se fijan a la pared mediante tornillos. Consultando los soportes fijados en la parte trasera del espejo, marque la posición de los orificios para los tornillos en la pared, verifique la horizontalidad de las marcas con un nivel de burbuja. También asegúrese (alineado con el centro del lavabo o pila) que el espejo esté centrado de acuerdo con la instalación.



05 Una vez realizadas las comprobaciones, taladre la pared (no utilice un taladro percutor en las baldosas para no estallar el azulejo) taladre dos agujeros de Ø 8 - 40 mm.



06 Coloque los tacos y los tornillos. Verificar el nivel una última vez antes de colgar el espejo.

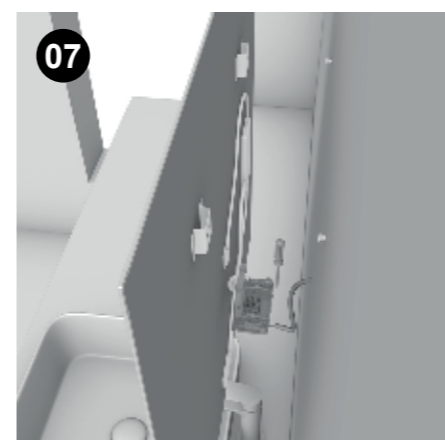

07 Abra la caja de conexiones entregada con el espejo, todos los conductores deben ser accesibles. Dependiendo del tipo de luz en su espejo, tendrá dos cables para conectar.

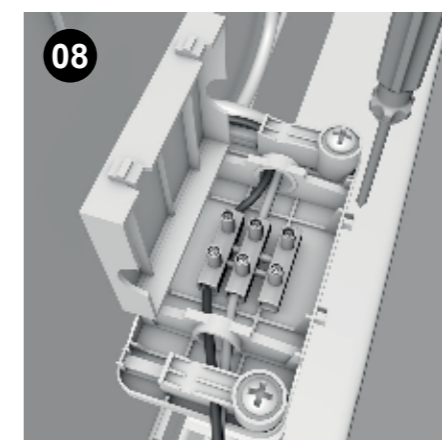

08 Conecte primero el cable del neutro (azul) y posteriormente la fase (rojo, negro o marrón). Cierre la caja de conexiones para que permanezca aislada y las conexiones protegidas. Nota: En la mayoría de los casos, la luz del espejo no tiene un conector a tierra, ya que se dice que tiene "doble aislamiento".



09 Verifique si la caja eléctrica está bien escondida, finalmente, si el cable de alimentación del espejo es demasiado largo, puede fijarlo a la pared con cinta adhesiva en un bucle ancho asegúrese también de que este cable no esté bajo tensión cuando el espejo esté sobre sus soportes.



10 Compruebe la correcta posición del espejo.

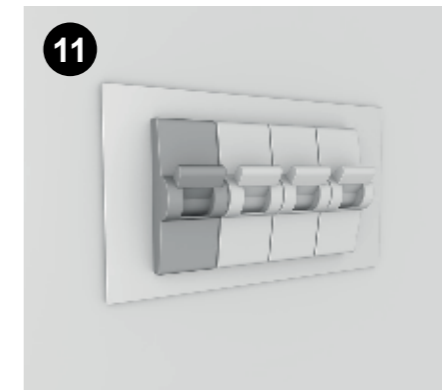

11 Vuelva a conectar el suministro eléctrico.



12 Pruebe la iluminación de su espejo.

Assembly instructions · Instructions de montage Instruções de montagem

Square or round mirrors · Miroirs carrés ou ronds · Espelhos quadrados e redondos



CONDICIONES GENERALES DE VENTA

GENERAL CONDITIONS OF SALE

CONDITIONS GÉNÉRALES DE VENTE

CONDIÇÕES GERAIS DE VENDA



ENTREGAS

Revise la mercancía a la recepción de la misma. No se aceptará ninguna reclamación sobre mercancía no revisada en el momento de su recepción. El transportista indicará tal efecto en el albarán de entrega.

DEVOLUCIONES

En caso de devolución defina claramente el motivo de la misma. LEDIMEX aceptará toda devolución que cumpla las siguientes premisas: El material deberá tener algún defecto de fabricación. El embalaje deberá estar en perfecto estado, de no ser así se le aplicará un recargo de un 10% en factura en concepto de recepción, revisión y manipulación.

FORMA DE PAGO

Se emitirá recibo a través de entidad bancaria. Giro máximo 60 días fecha factura. Cualquier impagado que se produzca conllevará el pago de la factura más todos los gastos bancarios ocasionados y retención de todos los pedidos hasta el pago del mismo.

TRIBUNALES

En caso de litigio ambas partes se someterán a los tribunales de Torrent (VALENCIA).

PORTES

Se cargarán 9,50 € de portes para aquellos pedidos que no superen los 150 € netos. Portes solo válidos para Península. Para Islas Baleares, Canarias, Ceuta, Melilla o fuera del territorio nacional consultar.



DELIVERIES

Check the not reviewed at the time of receipt will be accepted. The carrier will indicate such effect on the delivery note.

RETURNS

In case of return, clearly define the reason for the return. LEDIMEX will accept any return that meets the following premises: The material must have a manufacturing defect. The packaging must be in perfect condition, otherwise a 10% surcharge will be applied to the invoice for receipt, review and handling.

PAYMENT TERMS

A receipt will be issued through the bank. Maximum 60 days from invoice date. Any unpaid that occurs will entail the payment of the invoice plus all the bank charges incurred and retention of all the orders until the payment thereof.

COURTS

In case of dispute, both parties will submit to the courts of Torrent (VALENCIA).

DELIVERY COST

9.50 € postage will be charged for orders that do not exceed 150 € net. Shipping only valid for Peninsula. For the Balearic Islands, the Canary Islands, Ceuta, Melilla or outside the national territory, consult.



RÉCEPTION

Vérifier la marchandise à sa réception. Aucune réclamation ne sera acceptée si cela n'est pas fait au moment de la livraison. En cas d'incidence, le transporteur devra l'indiquer sur le bon de livraison.

RETOUR

En cas de retour de marchandise, merci d'indiquer clairement la raison. LEDIMEX acceptera la marchandise en retour dans les cas suivants: Matériel avec défaut de fabrication. L'emballage doit être en parfait état. Si ce n'est pas le cas, un surplus de 10% sera facturé en concept de réception, révision et manipulation.

CONDITIONS DE PAIEMENT

LCR émise par banque. Délais maximum 30 jours après la date e la facture. En cas de non-paiement d'une facture arrivée à échéance, le client assume-ra les frais bancaires occasionnés et la gestion des commandes sera bloquée.

LOI APPLICABLE

En cas de litige, les deux parties seront soumises au tribunal de Torrent (Valencia).

FRAIS DE PORT

9,50 € de frais de port seront facturés pour les commandes n'excédant pas 150 € net. Expédition valable uniquement pour la péninsule. Pour les îles Baléares, les îles Canaries, Ceuta, Melilla ou en dehors du territoire national, consultez.



ENTREGA

Verifique a mercadoria no recebimento da mesma. Não se aceitará nenhuma reclamação, sobre a mercadoria não revista no momento da sua recepção. O transportador, indicará esse efeito na nota/guia de entrega.

DEVOLUÇÕES

Em caso de devolução defina/explicite claramente o motivo da mesma. A LEDIMEX aceitará qualquer devolução que cumpra as seguintes condições: O material deve ter algum defeito de fabricação. A embalagem deve estar em perfeito estado, de 10% na factura de recepção, revisão e manipulação.

FORMA DE PAGAMENTO

O recibo será emitido através da entidade bancária. Máximo 60 dias da data da fatura. Qualquer falta de pagamento implicará o pagamento da factura acrescida de todos os custos bancários ocasionados e retenção de todas as encomendas até ao pagamento do mesmo.

TRIBUNAIS

Em caso de litígio, ambas as partes submeter-se-ão aos tribunais de Torrent (Espanha).

TRANSPORTE

Serão cobrados 9,50 € de portes para as encomendas que não excedam os 150 € líquidos. Portes válidos apenas para Península. Para as Ilhas Baleares, Canárias, Ceuta, Melilla ou fora do território nacional consultar.